

Installation Manual Punch Press Control

Model 3200

Includes:

SSM-05

SSM-10

SSM-20



Completely prewired and ready for installation.



Easy mounting into an existing control panel.

SAFETY INSTRUCTIONS



⚠️ WARNING

Read and fully understand this manual. Failure to do so could result in death or serious injury.





DANGER indicates a hazardous situation which, if not avoided, will result in death or serious injury.



WARNING indicates a hazardous situation which, if not avoided, could result in death or serious injury.



CAUTION indicates a hazardous situation which, if not avoided, could result in minor or moderate injury.



NOTICE is used to address practices not related to physical injury.



Safety Instructions (or equivalent) signs indicate specific safety-related instructions or procedures.

Machinery Guards and Controls

✓ for
info

Punch Press Controls (Resolver or Rotary Cam Based)

Punch Press Automation Controllers

Time-Based Brake Monitors

Mute-out Packages

Components & Accessories

Brake Performance Tester

Press Brake Guards and Controls

PressCam 8-“Control Reliable” Punch Press Automation

Controller: Programmable Limit Switch, 16 Station Die Protection System, Time-Based Brake Monitor, Five Counters, Servo-Feed Interface, Tonnage Monitoring, 150 Job Memory, 8” Operator Screen

Please send me information on the above marked items

Name: _____

Title: _____

Company: _____

Address: _____

City, State, Zip: _____

Phone: _____ Fax: _____

Email: _____

Fax your request to 412-262-1197

Pressroom *Electronics*™

P.O. Box 99875, Pittsburgh, Pennsylvania 15225
800-937-4334 412-262-1115 FAX: 412-262-1197

sales@pressroomelectronics.com

www.pressroomelectronics.com

Pressroom  *Electronics*™

www.pressroomelectronics.com

Punch Press Control

Model 3200

Includes:

SSM-05

SSM-10

SSM-20

Installation Manual

Pressroom Electronics, Inc.

3715 Swenson Avenue

St. Charles, IL 60174

P/N: 28-001r3-1

Customer Service: 630-443-9320 (CST)

(Please have Model #, Serial #, and Software Rev # Available)

Sales and Marketing: 800-937-4334 (EST)

Proper Usage

▲WARNING

The information disclosed herein includes proprietary rights of the manufacturer. Neither this document nor the information disclosed herein shall be reproduced or transferred to other documents, used or disclosed to others for manufacturing purposes, or for any other purposes, except as specifically authorized in writing by the manufacturer. If this manual is supplied in connection with the sale or delivery of manufacturer's equipment, it is to be used solely for maintenance, repair or installation of such equipment.

The Punch Press Control Model 3200 is to be used on part revolution air clutch punch presses. Before installation or using your Punch Press Control system, be sure you follow the described requirements:

- The Punch Press Control must be installed by qualified personnel.
- The press on which the Punch Press Control is installed must meet ANSI B11.1-2009 and OSHA 1910.217 regulations which include inspection and maintenance procedures that must be followed to meet these regulations. The manufacturer will NOT take responsibility for improperly maintained machinery.
- Point of operation safeguarding is spelled out in ANSI B11.19-2010. This regulation is used to determine a safe distance to place palm buttons, mechanical guards, safety curtains, and mats. Such equipment can be provided by the manufacturer but the Punch Press Control is not in itself a safeguarding device. The manufacturer takes no responsibility for operator injury as a result of improper safeguarding.
- The Punch Press Control may not be able to safely stop a press which has a faulty stopping mechanism. The manufacturer cannot be held responsible for an improperly maintained or working stopping mechanism.
- The Punch Press Control must be checked out before put into use. Follow this manual for procedures on how to do this.
- The Punch Press Control should not be modified or repaired except by qualified personnel and upon authorization of the manufacturer. Never operate machinery that is not in full working order.
- Make sure that all maintenance people, machine operators, die-setters, foremen, and supervisors have read and understand this manual.
- All procedures in this manual must be followed. All procedures in manuals of equipment attached to this Punch Press Control must be followed. The manufacturer cannot take responsibility for operation of the Punch Press Control if all procedures and warnings listed in all manuals are not followed.

▲WARNING

The entire machine safety system must be tested at the start of every shift. Machine testing should include: (1) proper machine operation and stopping capability; and (2) verification of proper installation and settings of all point of operation guards and devices before the operation is released for production.

Limitation of Liability

We have designed our equipment to the very highest performance and safety standards known to the current technological state of the art. However, the installation, usage, suitability, and fitness of our equipment for any purpose, known or unknown, is interdependent upon the performance of other equipment not manufactured, installed or secured or maintained by the manufacturer.

We cannot and do not accept responsibility for any overall system performance when factors, such as these, are beyond our control.

In the event of any claim for breach of any obligations of manufacturer under any order, whether expressed or implied, and particularly in the event of any claim of a breach of the warranty or warranties contained in the paragraph "WARRANTY" or of any other warranties, expressed or implied which might, despite the paragraph entitled "DISCLAIMER," be determined to be incorporated in any order, the company shall under no circumstances be liable for any consequential or special damages, either in law or in equity, or for losses or expenses or claims for the same arising from the use of, or inability to use, the products of the manufacturer for any purpose whatsoever.

Warranty

Manufacturer warrants that this product will be free from defects in material and workmanship for a period of two years on the Punch Press Control and one year on components from the date of shipment thereof. Within the warranty period, manufacturer will repair or replace such products which are returned with shipping charges prepaid and which will be disclosed as defective upon examination by the manufacturer. This warranty will not apply to any product which will have been subject to misuse, negligence, accident, restriction, and use not in accordance with manufacturer's instructions or which will have been altered or repaired by person's other than the authorized agent or employees of the manufacturer.

Disclaimer

The provisions of the paragraph "WARRANTY" are the sole obligations of the manufacturer and exclude all other warranties of merchantability, expressed or implied. Further, there are no warranties which extend beyond the above warranty.

ACTUATING PRESS VALVES

▲WARNING

Control Reliability requires that all Press's use only monitored DUAL SAFETY VALVES for the CLUTCH and monitored DUAL SAFETY VALVES on the BRAKE systems. Never operate a Press that uses a monitored DUAL SAFETY VALVE system on the CLUTCH but not the BRAKE (or vice versa). Dual Safety Valves used on press clutch/brake applications must be rated by the manufacturer for use on press clutch/brake applications.

Overview

Control Box Features	1
Control Station Features	1

Options

PressCam 8	2
BM-1600 Brake Monitor	2
SuperLight VI Safety Light Curtain.....	2
Zone Control (mat control)	2

Installation

52-119 CPU / Input Board.....	3
52-120 Power / Output Board	4
Control Box	5
Electrical Wiring	5
Interlocks.....	5
Clutch Solenoid Valve	5
Disconnect Switch.....	5
Limit Switches/Encoder Box	5
Operator's Station	5

Alignment and Setup

Adjusting the Cam Limit Switches.....	6
Adjusting the BM-1600 Brake Monitor	6
Adjusting the PressCam 8	6
Adjusting the Micro-Inch	6

Operation

Inch Mode	7
Single Stroke Mode.....	7
Continuous Mode	7
Hand / Foot Selector Switch	8
Emergency Stop	8
Bar Turnover (optional)	8
Forward / Reverse Selector (optional)	8
Interrupted Stroke	8
Top Stop Brake Indicator.....	8

Table of Contents

Appendix A: Troubleshooting

General	AA-1
Operational Display Messages	AA-1
External Error Messages	AA-2
Internal Error Messages.....	AA-3
Input / Output Designations	AA-6

Appendix B: Regulations and Guidelines

American National Standards Institute (ANSI).....	AB-1
Occupational Safety & Health Administration (OSHA).....	AB-2
Machine Control Reliability Requirements	AB-3
Safety Guidelines for Management.....	AB-4

Appendix C: Drawings

Circuit Board Dimensional Layout.....	AC-1
IEC Control Wiring Diagrams	AC-2 to AC-5
NEMA Style Switch Gear	AC-6 to AC-7

The Punch Press Control Model 3200 is used to control part revolution air clutch punch presses. A dual microprocessor logic system is incorporated into the control logic which meets ANSI B11.1-2009 regulation guidelines for microprocessor-based control systems. The Punch Press Control system will shut down if either redundant microprocessor logic system detects an internal or external fault. This configuration will safely shut down in the event of any single failure during the operation of the press.

A full four character alphanumeric diagnostics display scrolls messages in the event of a problem or failure. This display is used as an aid during troubleshooting.

Control Box Features

Depending on the selected options, the Punch Press Control box will contain a voltage transformer, dual microprocessor logic system, PressCam 8 or brake monitor, micro-inch circuit, bar turnover, motor starter.

Keylock Selector Switches

- 4 POS. Mode Select (Off/Inch Mode/Single Stroke Mode/Continuous Mode)
- 2 POS. Hand/Foot Mode
- 2 POS. Light Curtain (on/off)
- 2 POS. Palm Button Station on/off (if more than one station)
- 2 POS. Micro-Inch on/off (optional)

Push Buttons

- System Start - to start the press control or reset the system
- System Stop - to stop the press control
- Continuous Arm - to allow continuous operation
- Motor Start (optional) - to start the press motor
- Motor Stop (optional) - to stop the press motor

Indicator Lights

- System On
- Ground Fault - The white light is lit when the system is on and the control circuit is properly grounded. If a ground fault occurs, the fuse will blow causing the light to go out and prevent the operation of the press.

CAUTION

The ground light must be lit at all times when the press is under power. If the light is off when the power is on, locate and correct the problem before operating the press.

- Top Stop Brake failure
- Stroke Interrupt

Display Readouts

- Four character alphanumeric diagnostics display
- Three digital display on Brake Monitor BM-1600 (optional)
- Ten digit display on PressCam 8 (optional)

Control Station Features

The Control Station will have two palm buttons, a red "Emergency Stop" button, and a yellow "Stop on Top" button to stop continuous mode.

Options

Punch Press Control / Model 3200

PressCam 8

The PressCam 8 replaces the mechanical cam switches with a resolver transducer, designed to withstand hostile environments and provides the control system with multiple timing signals that can be programmed at the press control panel to trip at any position of the press. These timing signals can be used for controlling feeds, transfers, blow-offs, lubrication, die protection, indexing, and even the machine controls themselves to initiate clutch/brake assemblies.

Features:

- 8" diagonal LCD display
- Time-based brake monitor
- 16 die inputs
- 11 channel programmable limit switch
- Variable speed compensation
- Multiple on/off's per cycle
- Counters, timers, and tachometer
- Shaft angle position
- 75 program memory

BM-1600 Brake Monitor

The BM-1600 Brake Monitor adds a time-based brake monitor, chain break detection, and tachometer to the press control panel. The encoder for the brake monitor comes installed inside the cam limit switch housing and does not need to be adjusted. The BM-1600 Brake Monitor has a three digit display to indicate SPM, stop time (mSEC), and diagnostic codes. The BM-1600 Brake Monitor has its own manual which includes information on proper setup and how to calculate the proper set-points.

SuperLight VI light curtain

The light curtain is an infrared presence sensing device that is mounted between the press operator and the point of operation. When placed the correct distance in front of the pinch point, the press will shut down when the operator tries to reach into the press and breaks the infrared beams of the light curtain. The SuperLight VI is made up of two self-contained pylons placed across the guarded zone and contains a redundant microprocessor system with a diagnostics display. All light curtains include an installation manual that will instruct you on how to install and calculate the proper safety distance.

Zone Control (Mat Control)

If the area you are trying to guard has no defined pinch point (i.e., robotics equipment) you may want to guard the area with a safety mat. When stepped on, the zone control box will signal the press control to shut down. The control can be set up for either automatic or manual reset. The zone control includes a manual that will instruct you on how to install and calculate the proper safety distance.

52-119 CPU / Input Board

The 52-119 can be configured as a Master or Slave board (one of each is required for operation)

Designator	Description
0 - 31	LED indicator for each input
J1	Jumpers installed to configure board as Master
J2	Jumpers installed to configure board as SLAVE
J3	Ribbon cable link between Master, Slave, and 52-120 power supply board
J4	Jumper Right 2 pins for Master, Left 2 pins for Slave
J5	Jumper Left 2 pins for Master, Right 2 pins for Slave
J6	Ribbon cable link between Master and Slave 52-119 boards
J7	Cable to Diagnostics Display
J8-J10	Opto Inputs 0-31 (Sourcing)
D65	+5vdc LED

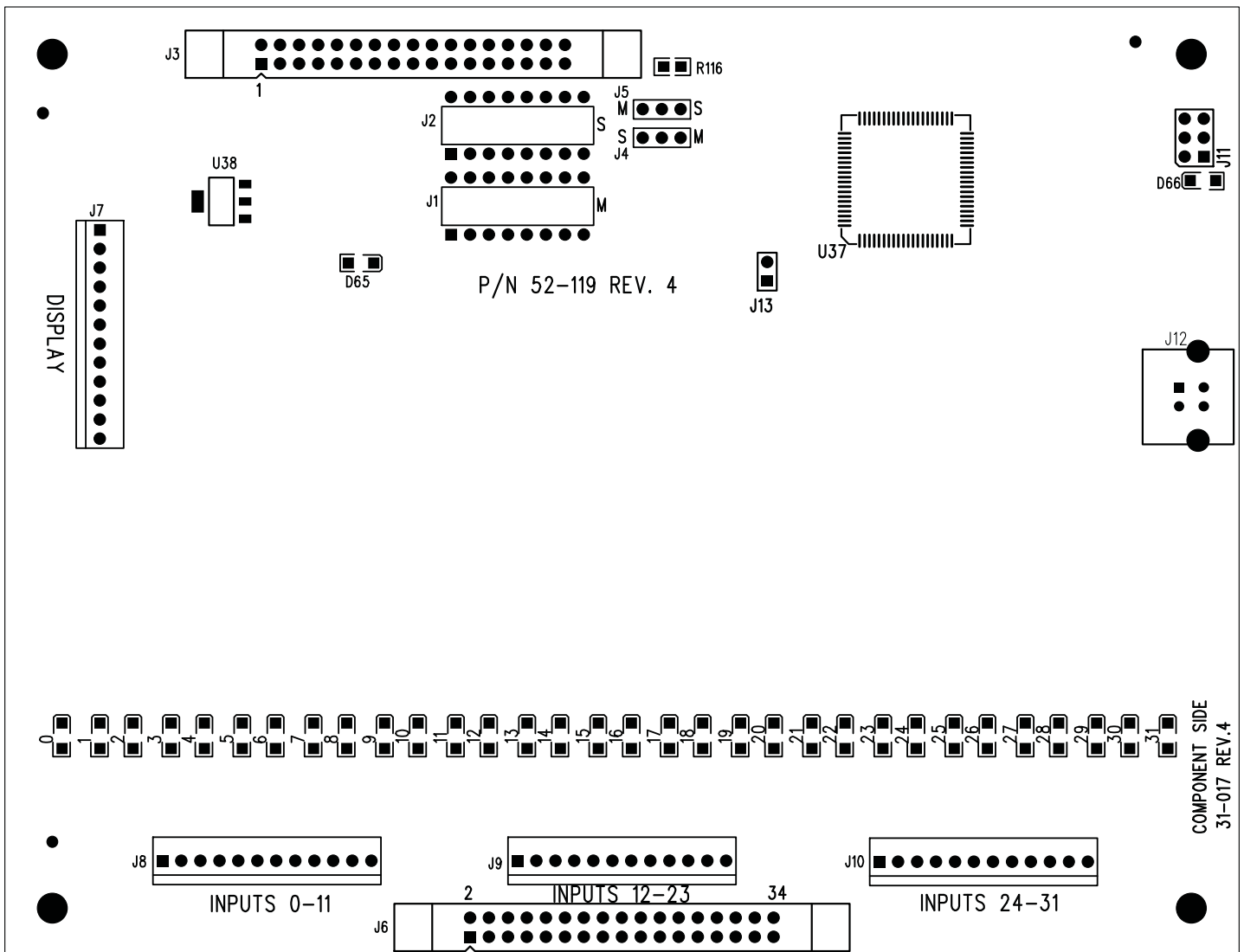

COMPONENT SIDE
31-017 REV.4

Installation

Punch Press Control / Model 3200



52-120 Power / Output Board

NOTE: All relay outputs are DRY contacts

Designator	Description
J1	Ribbon cable link between Power Supply 52-120, Master and Slave 51-119 boards
J2-1	Valve Output #1 K1(Both #1 and #2 must be used)
J2-2	Valve Output #2 K2
J2+24vdc	+24vdc output for use as common signal through switchgear back to the Opto Inputs.
J2-3	K7 Ground Fault Indicator when open
J2-4	K6 Light Curtain power when closed
J2-5	K5 Stroke Interrupted when closed
J2-6	K4 System ON when closed
J2-7	K3 Top Stop when closed
J2-COM	Common connection for K3-K7 Relay outputs
J2-G-N-L	Line Voltage Input (default is 120vac, optional 24vdc or 240vac) (24watts max)
F1	Fuse for Input Power (1A slow-blow) PN# 20-022
F2	Fuse for +24vdc J2-COM (1A slow-blow) PN# 20-018
A-B	Jumper configuration for selecting 120vac or 240vac
D2	LED for +24vdc
D51	LED for +5vdc
D53	LED for +12vdc
D11-D12	LED ON when Relays K1-K2 closed (active)
D13-D17	LED ON when Relays K3-K7 closed (active)

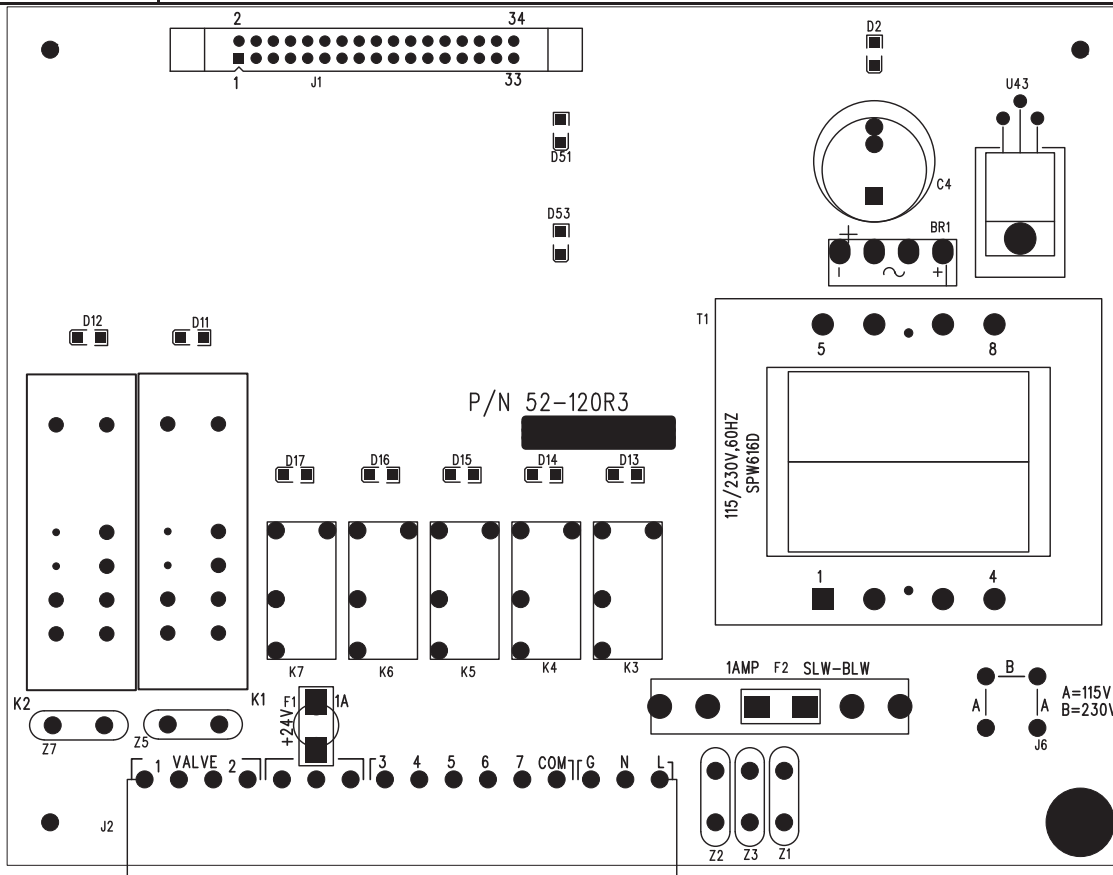

⚠️ WARNING

The entire machine safety system must be tested at the start of every shift. Machine testing should include: (1) proper machine operation and stopping capability; and (2) verification of proper installation and settings of all point of operation guards and devices before the operation is released for production.

Control Box

Mount the Control Box at any convenient location on or near the press. If it is mounted on the press, you must shock mount the enclosure against vibration. If the operator's controls are located on the enclosure, it should be mounted such that the operator has easy access to the enclosure and can readily see the controls from in front of the press.

Electrical Wiring

Refer to Appendix C and interconnect the electrical components as shown. A separate earth ground conductor must be connected to the "G" terminal in the ground panel. This wire **must** be connected to an earth ground such as a grounding rod or a water pipe. The press should be grounded in a similar manner. **Do not** operate the press if this ground wire is not connected. Follow the National Electric Code, all state and local codes, and all applicable sections of OSHA when wiring the press.

Interlocks

On systems with air and power interlock function, additional interlocks may be wired into the system as shown in the wiring diagrams (refer to Appendix C).

Clutch Solenoid Valve

The clutch solenoid valve should be mounted as close as possible to the clutch cylinder or air clutch. The hose or pipe from the valve to the cylinder or air clutch should be as short as possible and at least the same size as the port on the cylinder or air clutch.

Disconnect Switch

If the control enclosure is provided without a main power disconnect switch, a switch capable of being locked in the off position only should be provided on or near the press.

Limit Switches / Encoder Box

Limit switches are driven via a rotary cam switch box with a built in drive failure switch that signals the press in the event of a chain break. The limit switch mounting should be as close to the crank as possible.

- The Rotary Cam Switch (RCS) contains all the limit switches needed by the press control as well as a drive check switch used for chain break detection. The RCS must be linked to the press via a chain in a 1:1 configuration.
- If the optional BM-1600 Brake Monitor was ordered with the press control, then the RCS assembly has the encoder needed by the BM-1600 Brake Monitor inside along with the limit switches. See the BM-1600 Brake Monitor manual for details. Wire the BM-1600 Brake Monitor encoder cable to the RCS according to the BM-1600 Brake Monitor manual.
- If the optional PressCam 8 was ordered with the press control, then there are no physical limit switch's. The PressCam 8 uses an absolute positioning transducer that mounts in a similar fashion as the RCS. The PressCam 8 is then programmed to produce the action of a physical limit switch as the press turns the transducer. See PressCam 8 manual for instructions on how to program the unit.

Operator's Station

The operator's control station, or the Run (or Inch) palm buttons, if supplied separately, should be mounted on the press such that the operator can easily reach the controls. They should be mounted far enough away from the point of operation, or other hazard, such that the operator is protected against accidental contact with the point of operation (see ANSI regulations in Appendix B: Rules and Regulations).

Additionally, both palm buttons should be mounted such that the operator is required to use both hands to operate the press. **They should be far enough apart (minimum of 25") such that a hand and an elbow of the same arm nor any other part of the body except the other hand may be used to operate the press.** Both palm buttons must be wired to their correct inputs. They **must not** be wired in any other way. The press control contains the anti-tie-down programming needed to protect the operator from running the press with one hand. Each operator or his helper must have his own set of palm buttons to operate the press.

Adjusting the Cam Limit Switches

Refer to the timing chart in Appendix C as well as the control wiring diagrams provided.

- Limit Switch LS1 is used to Top Stop the Press. It is normally CLOSED, and OPEN when you want the VALVES to turn OFF. LS1 must remain OPEN for at least 10° (and longer for speeds faster than 150SPM). Where the Press comes to a Stop depends on Brake performance and Press speed.
- Limit Switch LS2 is used as a back check for LS1 and as a position based Brake Monitor. It is normally OPEN, CLOSING at least 10° before LS1 OPENS. LS2 must remain CLOSED past Top Dead Center to 5°. If the Press stops past this point, a Brake Monitor fault will occur.
- Limit Switch LS3 is used for Auto Return and Guard By-Pass. It is normally OPEN, CLOSING when the DIE is 1/4" from being closed. LS3 remains CLOSED for 10°.

Adjusting the BM-1600 Brake Monitor

Locate the installation manual for the BM-1600 Brake Monitor that came with the press control. If the press came with a Rotary Cam Switch (RCS) assembly, then the encoder needed by the BM-1600 Brake Monitor inside along with the limit switches. If no RCS was ordered with the press, a separate encoder box is provided. Wire up the BM-1600 Brake Monitor encoder cable to the RCS or encoder box according to the BM-1600 Brake Monitor manual. Now, you must use the "90° From Top Stop" feature of the BM-1600 Brake Monitor to compute a worst case stop time for your press. Follow the instruction manual on selecting the correct stopping / warning times for your press.

Adjusting the PressCam 8

Locate and follow the installation manual on the PressCam 8 provided with the press control. Set up the three limit switches by following the PressCam 8 manual. Set up the BM-1600 Brake Monitor by following the PressCam 8 manual.

WARNING on ROTARY CAM INSTALLATION

WARNING

Control Reliability requires that you must install any "Rotary Cam" box using the Spring Plate "Drive Check" (or "Chain Break") circuit properly attached to the Press Control input(s). You must mount/install the "Rotary Cam" box in such a way that the Spring Plate will open the "Drive Check" circuit should the linkage between Press and the "Rotary Cam" box fail.

If you cannot mount/install the "Rotary Cam" box using the Spring Plate "Drive Check" circuit, you MUST install a separate device that checks for MOTION of the press. The BM-1600 Brake Monitor can be installed to fulfill the requirement for MOTION detection. The BM-1600 would be wired into the STOP circuit of the Press Control. The Motion Detect setpoint must be set to the lowest value that allows the Press to operate.

Adjusting the Micro-Inch

A timer for Micro-Inch is located inside the press control box. An on/off keylock selector switch is provided on the control panel. Set the press up in "Inch" / "Hand" mode and turn the "Micro-Inch" keylock on. The amount of travel of the press depends on the time selected on the Micro-Inch timer and the speed of the press. Adjust the timer for the shortest interval. Operate the press. Go back and re-adjust the timer until the desired amount of travel is obtained.

Inch Mode

WARNING The Inch Mode of operation is intended for die setting and tryout work only and should never be used for production runs.

- Set the keylock mode selector switch to “Inch.”
- Concurrently activate both palm buttons on the run bar to start the slide moving.
- The slide will stop when one or both run buttons are released.
- The slide can be moved in small increments by momentarily activating both palm buttons.
- The motor can be turned off and the flywheel allowed to coast to slower speeds for finer increments.
- If the press is equipped with a reversing starter, the slide can be inched either forward or reverse.
- The press can only be inched with the palm buttons and not with a foot switch, if supplied.
- If you have the Micro-Inch option you can use this to move the slide in precise increments.

Single Stroke Mode

The Single Stroke Mode is a production mode of operation. The slide starts from the top of the stroke, comes down and performs the operation, returns to the top, and stops.

NOTICE The point of operation must be properly guarded by the user (employer).

- Set the Keylock Mode Selector Switch to “Single Stroke.”
- Select either hand or foot operation from the keylock switch.
- If Hand Mode is selected, you must concurrently activate both palm buttons on the run bar to operate the press.
- The two palm buttons must be held depressed during the downward motion of the slide, otherwise the slide will stop and the “Stroke Interrupt” light will come on.

- After the slide reaches the bottom of the stroke, the palm buttons can be released.
- When the slide returns to the top, you must release both palm buttons to start the next stroke.
- If foot mode is selected, you must depress the foot switch to operate the press.
- The foot switch must be held down during the downward motion of the slide, otherwise the slide will stop and the “Stroke Interrupt” light will come on.
- After the slide reaches the bottom of the stroke, the Foot Switch can be released.
- If the “Stroke Interrupt” light comes on, the press control will automatically change over to the “Inch” / “Hand” mode to allow you to move the slide back to top stop.
- When the slide returns to the top, you must release the foot switch to start the next stroke.

Continuous Mode

The Continuous Mode is a production mode of operation used with automatic feed equipment.

NOTICE The point of operation must be properly guarded by the user (employer).

- Set the Keylock Mode Selector Switch to “Continuous.”
- Select the “Hand” mode on the Keylock Switch
- Depress the “Continuous Arm” button.
- You now have five seconds to concurrently activate both palm buttons to start the press.
- You must hold in the palm buttons for two cycles to lock in continuous mode.
- To stop the continuous cycle, depress the yellow “Stop on Top” button located on the run bar. The slide will complete the present stroke and stop on top.
- This mode will only operate in the hand mode only.

Operation

Punch Press Control / Model 3200

SAFETY INSTRUCTIONS

Hand / Foot Selector Switch

Palm buttons located on the run bar are the standard operating means for all punch presses. An optional foot switch can be furnished in addition to the palm button station.

- When the Keylock Selector Switch located on the electrical control box is switched to “Hand,” the palm buttons will operate the press in “Inch,” “Single Stroke,” and “Continuous” modes of operation.
- When the Keylock Selector Switch is switched to “Foot,” the foot switch is active and the palm buttons are inactive.
- The foot switch can operate the press in the “Single Stroke” mode of operation only. Any other mode will automatically disconnect the power to the controls.
- In “Single Stroke,” you must use the “Hand” mode to return the press to top stop if you interrupt the press on the down stroke while in “Foot” mode.

Emergency Stop

The large red mushroom head “Emergency Stop” button is located on the operator’s station (run bar). When the “Emergency Stop” button is pressed, the slide will stop immediately and power to the main drive motor will be shut off.

Bar Turnover (optional)

Bar Turnover allows manual rotation of the flywheel with the clutch engaged for die setting. Turn Keylock Selector Switch (Bar Mode) to “On” Remove cover from flywheel guard. Wait until flywheel stops rotating. Insert the turnover bar. Depress the “Bar” button to engage the clutch and allow positioning of the ram.

NOTICE

A motion detection must be used to assure flywheel has stopped rotating before clutch can be engaged via pushbutton.

Forward / Reverse Selector (optional)

The Forward/Reverse Keylock Selector Switch located on the electrical control box allows the press to be run in the reverse direction by operating the main drive motor in the reverse direction. The press is generally operated in reverse during die setting or when the slide is stuck on bottom and has not passed through bottom dead center.

- To operate the press in the reverse direction, allow the flywheel to come to a complete stop, switch the Keylock Selector Switch to “Reverse.”
- Select “Inch Mode” from the Keylock Selector mode Switch.
- Select “Hand Mode” from the Keylock Selector Switch.
- Depress the black “Motor Start” button.
- The press can only be operated in the reverse direction with the selector switch in the “Inch” mode and “Hand” mode.

Interrupted Stroke

This feature is triggered when the press is in either the “Single Stroke” or “Continuous” mode and the press stops before the completion of a full stroke. The control will automatically switch to the “inch” mode and the palm buttons must be used to return the ram to the top of the stroke. When back at the top, the control switches back to the original setting and the operator may resume as before.

Top Stop Brake Monitor

The Top Stop Brake Monitor is designed to indicate increased stopping time at the top of the stroke. Limit Switch LS2 is to be set to open at the top of the stroke when the angle or degrees specified by the manufacturer is exceeded.

Example: If the press control is set so the press stops at 0 degrees, it is up to the user to determine how much additional over travel will be allowed before the Top Stop indicator will be activated. If the user sets LS2 to open at 2 degrees, the system will lock out if the press stops at 2 degrees or greater. When this happens, the brake **must be** adjusted or repaired.

Do not readjust LS2 to prevent lockout unless stopping time is measured and safety distance is adjusted.

General

If the press will not operate, check the following:

- Power to the press control is disconnected when the mode selector is in the "Off" position or in the "Inch" or "Continuous" modes while the hand/foot selector is in "Foot" mode.
- Check the Diagnostics Display on the front control panel. Any discrepancy between the redundant control logic systems or a fault within one of the systems will force a message to scroll across the display. The message should be fairly self explanatory, however, a detailed description can be found under External Error Messages in this section.
- With the system energized and the "Start" button pushed, both "System On" and "Ground" indicator lights should be lit. If not, check the stop circuit. Input #1 LED should be on.
- With both lights on (see above) and the ram at the top of the stroke, the following LED's on the controller should be lit:

Input	1	=	STOP
	6	=	LS1
	7	=	LS2
	13	=	GUARD CONTACT NC
	14	=	TOP STOP NC
	15	=	CHAIN BREAK NC
	16	=	PRESSURE SWITCH #1 NC
	17	=	PRESSURE SWITCH #2 NC
	18	=	ESTOP NC
	19	=	DIE INPUT NC
	20	=	Station #1 ON/OFF

Inputs are from #0 to #31

- When setting limit switches, make sure that LS2 closes before LS1 opens. Also, LS1 should close before LS2 opens. If the ram stops before the top of the stroke, advance LS1 and LS2. Conversely, if the ram stops after the top of the stroke, retard both LS1 and LS2.
- If the motor starter is wired by the manufacturer, the press will only operate in the "Inch" mode if the motor key switch is in the reverse position.

- The motor starter should have an auxiliary contact wired N.O. which will close when the motor is running in "FWD" to allow single and continuous operation.

To clear an error message from the diagnostics display, press "Stop."

Operational Display Messages

Messages that appear on the display, but no fault has occurred.

MESSAGE: OFF
PURPOSE: Indicates that the computers are powered up and operating properly awaiting the "START" button.

MESSAGE: INCH
PURPOSE: Either the key selector is in the "Inch" mode or the "Stroke Interrupt" light is on and control has reverted to "Inch" mode until you finish the stroke and return the press back to top stop. If the key selector is in "Foot" mode, the power to the controller will be disconnected and nothing will be displayed.

MESSAGE: SNGL
PURPOSE: The key selector is in the "Single Stroke" mode. If you stop the press before the bottom (LS3), the control will automatically revert to "Inch" mode until you return the press to top stop and force you to use the "Hand" mode even if you selected the "Foot" mode. Once you reach top stop, control will revert back to "Single Stroke" mode again.

MESSAGE: CONT
PURPOSE: The key selector is in the "Continuous Stroke" mode and awaiting you to press the "Continuous Arm" button (see below).

Appendix A: Troubleshooting Punch Press Control / Model 3200

SAFETY INSTRUCTIONS

MESSAGE: **ARMD**
PURPOSE: Indicates that the press is in continuous mode and the “Continuous Arm” button was pushed. Once pressed, you now have five seconds to activate all the palm button stations that are turned on. Once you activate the stations, you must keep them active for two press strokes, otherwise the control will not lock into continuous mode and you will get an error message.

MESSAGE: **STOP**
PURPOSE: Indicates that the “Stop” button is being pushed. The display will return to display “Off” when you release this button. You can use this button to clear error messages from the display.

MESSAGE: **ESTP**
PURPOSE: Indicates that the “Emergency Stop” button is being pushed. The display will return to display “Off” when you release this button. You can use this button to clear error messages from the display.

MESSAGE: **TSTP**
PURPOSE: Indicates that the “Top Stop” button is being pushed. This button is used to return the press to top stop during continuous mode operation.

External Error Messages

Messages that indicate an error occurred outside the control box.

MESSAGE: **PLM1, PLM2, PLM3, PLM4**
PURPOSE: Indicates that only one of the two palm buttons at a particular station (1,2,3,4) had activated within 1/4 second and that the other palm button either was activated too late or never. There can be up to four palm button stations.

SOLUTION: Try turning on only one palm button station and activating both palm buttons simultaneously. Check the palm button LED’s on the press control itself to see if they are both activating (see “Input/ Output Designations at the end of the section).

MESSAGE: **YOU MUST HOLD BUTTONS FOR 2 CYCLES**

PURPOSE: “Continuous” mode requires you to cycle the press for two cycles before locking into “Continuous” mode.
SOLUTION: You must hit the “Stop” button to clear this message then, if the press is not at top stop, you must select either “Single Stroke” or “Inch” modes to return the press to top stop before trying “Continuous” mode again.

MESSAGE: **CHAIN BREAK**
PURPOSE: Rotary Cam Drive switch opened up indicating the chain driving the limit switches is broken or wiring is bad.

SOLUTION: Check this input to see if LED is on.
a) If LED is on, then the PLC board must be replaced.
b) If LED is off, then either the chain is broken or the switch is bad.

MESSAGE: **PRESSURE SWITCH 1 FAULT**
PURPOSE: Air pressure going to the clutch is either low or high

SOLUTION: Check this input to see if LED is on.
a) If LED is on, then PLC board must be replaced.
b) If LED is off, then check air pressure and valve.

MESSAGE: **PRESSURE SWITCH 2 FAULT**
PURPOSE: Air pressure going to the clutch is either low or high

SOLUTION: Check this input to see if LED is on.
a) If LED is on, then PLC board must be replaced.
b) If LED is off, then check air pressure and valve.

MESSAGE: **LS1L**
PURPOSE: Limit switch 1 is stuck open (off) and never closed (on). LS1 should open up just after LS2 closes but close again to signal top stop.

SOLUTION: a) LS1 may be open for too large an angle
b) LS2 may be closed for too short an angle (see Alignment and Setup section).
c) Limit switch is broken or wiring is open.
d) Press was started from a position other than top stop
To clear this error you must press the “Stop” button.

MESSAGE: LS1H
PURPOSE: Limit switch 1 is stuck closed (on) and never opened (off). LS1 should have opened up while LS2 was closed.

SOLUTION:

- a) LS1 may be opened for too small an angle to be sensed (see Alignment and Setup section).
- b) Limit switch is broken or wiring is shorted.
- c) Press was started from a position other than top stop

To clear this error you must press the "Stop" button.

MESSAGE: LS2L
PURPOSE: Limit switch 2 is stuck open (off) and never closed (on) during the stroke. This will cause the "Top Stop Brake Monitor" light to go on.

SOLUTION:

- a) LS2 may be closed for too small an angle to be sensed (see Alignment and Setup section).
- b) Limit switch is broken or wiring is open.

To clear this error, you must press the "Stop" button.

MESSAGE: LS2H
PURPOSE: Limit switch 2 is stuck closed (on) and never opened (off) during the stroke. It should be open before it reaches LS3.

SOLUTION:

- a) Limit switch may be set to close at the wrong time (see Alignment and Setup section).
- b) Limit switch is broken or wiring is shorted.
- c) Press was started from a position other than top stop

To clear this error you must press the "Stop" button.

MESSAGE: LS3L
PURPOSE: Limit switch 3 is stuck open (off) and never closed (on) during the stroke.

SOLUTION:

- a) LS3 may be closed for too small an angle to be sensed (see Alignment and Setup section).
- b) Limit switch is broken or wiring is open.
- c) Press was started from a position other than top stop

To clear this error you must press the "Stop" button.

MESSAGE: LS3H
PURPOSE: Limit switch 3 is stuck closed (on) and never opened (off) during the stroke. It should be open before it reaches LS2 closed.

SOLUTION:

- a) Limit switch may be set to close at the wrong time (see Alignment and Setup section).
- b) Limit switch is broken or wiring is shorted.

To clear this error you must press the "Stop" button.

MESSAGE: INPUT(S) TOO NOISY
PURPOSE: All 24VDC inputs (up to 32) are optically coupled to the controller. The controller digitally filters out any noise caused by external devices (i.e., motors, solenoids, etc.) that may get inside the control box via one of the 24VDC inputs. However, there may be a time when there is too much noise to allow safe operation of the press. In this case the press will shut down.

SOLUTION:

- a) Check for loose wires on all terminal strips, including the controller boards.
- b) Check that the control box is connected to a good earth ground.
- c) Try and determine when this error message occurs during the stroke and if any specific valve, motor, solenoid, switch, etc. is switched on or off at that moment in time. You may need to place an MOV across the input of the offending device to quiet it down.

Internal Error Messages

Messages that indicate a fault in the controller itself.

MESSAGE: RST
PURPOSE: Indicates the Master has reset itself and the Slave has not indicated its presence.

SOLUTION: Power down the controller for 30 seconds and try to restart the controller again.

- a) Check the ribbon cable and the microprocessor chips. They may have come loose from their sockets.
- b) May be a bad Slave chip.

Appendix A: Troubleshooting Punch Press Control / Model 3200

SAFETY INSTRUCTIONS

MESSAGE: SLAVE PROGRAM DOESNT MATCH MASTER

PURPOSE: The program code running on the Slave board is not the same program version running on the Master board.

SOLUTION: Check Master program version number displayed at power up and compare it with what's written on the Master and Slave chips. Reset power and try again. If the problem persists, the slave chip may be incorrect or bad. Call manufacturer to determine which number is the correct one.

MESSAGE: VER 1.00

PURPOSE: This message does not indicate an error. It is used to indicate the software version number. The number to the left indicates the type of software. The number to the right indicates the revision number. As the version number is displayed, the system is self checking.

MESSAGE: MASTER ON, SLAVE OFF, CHECK INPUT #

PURPOSE: The top board (Master) sees an input signal that the bottom board (Slave) does not.

SOLUTION: Check the LED's on each board corresponding to the input number specified in the error message.

- a) If the Master LED in "On" and the Slave LED is "Off," then the problem is either in the wiring going to the Slave or the opto-coupled input on the Slave is bad and the Slave board must be replaced.
- b) If both Master and Slave LED's are on, then the problem is with the Slave board circuitry. The Slave board must be replaced.

MESSAGE: SLAVE ON, MASTER OFF, CHECK INPUT #

PURPOSE: The bottom board (Slave) sees an input signal that the top board (Master) does not.

SOLUTION: Check the LED's on each board corresponding to the input number specified in the error message.

- a) If the Slave LED in "On" and the Slave LED is "Off," then the problem is either in the wiring going to the Master or the opto-coupled input on the Master is bad and the Master board must be replaced.
- b) If both Master and Slave LED's are on, then the problem is with the Master board circuitry. The Master board must be replaced.

MESSAGE: RELAY 1 OR 2 IS ON, SHOULD BE OFF

PURPOSE: There are two safety relays (1 and 2) that are used to stop/start the press. The Master has detected that one or both relay's remained in the closed position when the relays were de-energized.

SOLUTION:

- a) Check the contacts on Relay #1 for pitting, scoring, or discoloration.
- b) Check for failed solder joint on PCB. PCB will need to be repaired or replaced.

MESSAGE: RELAY 1 OR 2 IS OFF, SHOULD BE ON

PURPOSE: The Master has detected that Relay #1 did not turn on when energized.

SOLUTION: Bottom board must be examined for relay failure.

MESSAGE: SLAVE RELAY 1 OR 2 IS ON, SHOULD BE OFF

PURPOSE: The Slave has detected that Relay #1 remained in the closed position when the relay was de-energized.

SOLUTION:

- a) Check the contacts on Relay #1 for pitting, scoring, or discoloration.
- b) Check for failed solder joint on PCB. PCB will need to be repaired or replaced.

MESSAGE: **SLAVE RELAY 1 OR 2 IS OFF,
SHOULD BE ON**

PURPOSE: The Slave has detected
that Relay #1 did not turn on when
energized.

SOLUTION: Slave board must be examined for
failure.

MESSAGE: **MASTER INTERNAL RAM BAD**

PURPOSE: Ram failed during the power
up test.

SOLUTION: Power down the press control system.
If the error occurs again when powered
up, then the Master microprocessor on
the top board must be replaced.

MESSAGE: **SLAVE INTERNAL RAM BAD**

PURPOSE: Ram failed during the power
up test.

SOLUTION: Power down the press control system.
If the error occurs again when powered
up, then the Slave microprocessor on
the lower board must be replaced.

MESSAGE: **CANNOT TALK TO SLAVE**

PURPOSE: Master microprocessor on
the top board cannot talk to the Slave
microprocessor on the bottom board.

SOLUTION: Check the ribbon cable for proper visual
termination. The PLC boards must
both be examined and repaired.

MESSAGE: **CHKSUM ERROR WITH SLAVE**

PURPOSE: Data sent from the Slave
computer to Master computer was
corrupted.

SOLUTION: One the of two PLC boards may have
reset due to noise causing them to fall
out of synchronization with each other.
Reset the power and try again. If it
continues to happen, check for loose
wiring and/or improper voltage levels
on the power lines or power supply
lines. Also, check for noise coming
from bad relay contacts nearby.

Appendix A: Troubleshooting

Punch Press Control / Model 3200

Input / Output Designations

The following is a list of Inputs and Outputs as wired to the dual microprocessor logic system:

Numbers start out from the left side, looking at the terminal strip from the front.

All inputs use output #6 as their common.

Inputs

0	START (N.O.)
1*	STOP (N.C.)
2	SINGLE STROKE (1)
3	CONTINUOUS MODE (1)
4	CONTINUOUS ARM (N.O.)
5	HAND (0) / FOOT (1)
6*	LS1 (OPEN to STOP)
7*	LS2 (Cross check for LS1 & brake check)
8	LS3 (Auto Return & Mute Out)
9	Palm Button 1 (N.O.)
10	Palm Button 2 (N.O.)
11	Foot Switch (N.O.)
12	Light Guard Key (ON=0, OFF=1)
13* - 13A*	Light Guard Contact (DUAL N.C.)
14*	TOP STOP (N.C.)
15*	CHAIN BREAK switch (N.C.)
16*	PRESSURE Switch 1 (N.C.)
17*	PRESSURE Switch 2 (N.C.)
18* - 18A*	ESTOP (DUAL N.C.)
19*	DIE FAULT (N.C.)
20*	PALM STATION Select 1 (1=ON)

NOTICE

For Startup testing, the Inputs (shown above) with an * must be ON (Input LED Lit). The control will be in INCH mode, HAND, GUARD ON, assuming the Press at Top dead center. Inputs 9-10 will be lit when you activate each Palm Button.

Optional Inputs

21	(OPTIONAL) PALM STATION Select 2
22	(OPTIONAL) Palm Button 3 (N.O.)
23	(OPTIONAL) Palm Button 4 (N.O.)
24	(OPTIONAL) PALM STATION Select 3
25	(OPTIONAL) PALM STATION Select 4
26	(OPTIONAL) Palm Button 5 (or FOOT SWITCH 2)
27	(OPTIONAL) Palm Button 6
28	(OPTIONAL) Palm Button 7
29	(OPTIONAL) Palm Button 8 (or External Trip Prior ACT N.O.)
30	(OPTIONAL) External Trip (ON=1, OFF=0)
31	(OPTIONAL) LS4 External Trip signal (N.O.)

NOTICE

When ordered with 2 or more PALM operator stations, the all Station Selects logic invert (from 1=ON to 0=ON).

Output

1 - 2	SAFETY Output VALVE #1 (dry contact)
3 - 4	SAFETY Output VALVE #2 (dry contact)
5	No connection
6	+20VDC (Common supply for INPUTS to the left)
7	No connection
8	GROUND Indicator Light
9	Light Guard Power
10	STROKE Interrupt Light
11	SYSTEM ON (for motor starter circuit and Light)
12	BRAKE MONITOR light
13	Common for 8 thru 12 (usually wired to LINE)

NOTICE

All **OUTPUTS** are mechanical 5A relay contacts, except for 6.

Power In

14	GROUND (Chassis/Earth and 0vdc)
15	NEUTRAL
16	LINE (110VAC standard)

American National Standards Institute (ANSI)

B11.1-2009

6.3.2 Presence-sensing Point of Operation Devices

A presence-sensing point-of-operation device, if used, shall protect the operator and others, and shall be interfaced with the control circuit to prevent or stop slide motion if the operator's hand or other body part is within the sensing field of the device during the closing portion of the stroke. In addition:

- (1) Presence-sensing devices shall not be used for safeguarding the point of operation on presses using full-revolution clutches.
- (2) When the sensing field has been interrupted, use of the normal press stroke initiating means shall be required after clearing the sensing field to resume press operation.
- (3) Muting (bypassing of the protective function) of the device shall be permitted after the hazardous portion of the press stroke has been completed. Muting of the device shall be accomplished in such a manner that no single component failure shall prevent the normal stop command but shall prevent subsequent press strokes until the failure is corrected.
- (4) The device shall have an identifiable minimum object sensitivity so that an obstruction of an equal or greater size will be detected anywhere within the sensing field regardless of the plane of intrusion.
- (5) The device shall have a maximum response time which shall not be affected by object sensitivity adjustments or environmental changes.
- (6) The devices which require adjustments to accommodate variations in ambient or operating conditions or which incorporate channel blanking or floating window features shall be designed so that the adjustments or features are capable of being supervised by the employer.
- (7) The presence-sensing device shall be provided with a means that visibly indicates when it is and is not in use and functioning properly. The device shall also indicate which sections, if any, have been blanked out.

- (8) The device shall not fail to respond to the presence of the operator's or other's hand or body part due to the presence of a reflective object or work piece.
- (9) The device shall be designed and constructed so that any single component failure, including output devices, shall not prevent the normal STOP command from being sent to the press, but shall prevent operation of the press stroke until the failure has been corrected. In the event of a power failure to the device, it shall initiate a STOP command to the press-control system.
- (10) The device and the press-control system shall be interfaced so that the device's STOP command shall initiate stopping action during the closing portion of the press stroke. The interface shall be designed to ensure that a single component failure within the interface of the control system shall not prevent the normal STOP command from being sent to the press, but shall prevent operation of the press stroke until the failure has been corrected.
- (11) The device's sensitivity to intrusion shall not be adversely affected by changing conditions around the press.
- (12) The effective sensing field of the device shall be located at a distance from the nearest point-of-operation hazard so that the operator or others cannot reach into the point of operation with a hand or other body part before cessation of motion during the closing portion of the stroke.
- (13) The device shall not be affected by ambient light or by light-source decay so that the increase in response time or object sensitivity is greater than the value used to calculate the safety distance.
- (14) All areas of entry to the point of operation not protected by the presence-sensing device shall be otherwise safeguarded.



Appendix B: Regulations and Guidelines Punch Press Control / Model 3200



- (15) When a device is used on a press in a single-stroke mode and when the protection of the operator is dependent upon the stopping action of the press, a stopping performance monitor shall be required.

B11.19-2010

6.3.5 Two-Hand Control Device

- (3) Each operator hand control shall be located at a distance from the point of operation so that the operator cannot release either hand control and reach into the point of operation prior to die closure or prior to cessation of slide motion during the closing portion of the stroke.

Below is the formula for calculating the safety distance of a light curtain or palm buttons. The machine stop time should be measured with the machine running at its fastest speed with its heaviest die or tooling and the stop time being measured at the 90° position in the downstroke. The following formula should be used when calculating the safety distance:

$$DS = K \times (TS + TC + Tr + Tbm)$$

- DS = Minimum safety distance between the device and the nearest point of operation hazard (in inches).
- K = Hand speed constant. This value has been determined by various studies and although these studies indicate speeds of 63 in/sec to over 100 in/sec, they are not conclusive determinations. The employer should determine this value by considering all factors, including physical ability of the operator.
- TS = Stop time of the machine tool measured at the final control element.
- TC = Response time of the control system. NOTE: TS and TC are usually measured by a stop time measurement device.
- Tr = Response time of the presence-sensing device and its interface, if any, as stated by the manufacturer or measured by the employer.
- Tbm = Additional time allowed for the brake monitor to compensate for variations in normal stopping time.

Occupational Safety & Health Administration (OSHA)

1910.217 (C) (3) (iii)

Safeguarding the Point of Operation

- (iii) A presence sensing point of operation device shall protect the operator as provided in paragraph (c) (3) (i) (a) of this section, and shall be interlocked into the control circuit to prevent or stop slide motion if the operator's hand or other part of his body is within the sensing field of the device during the downstroke of the press slide.
 - (a) The device may not be used on machines using full revolution clutches.
 - (b) The device may not be used as a tripping means to initiate slide motion.
 - (c) The device shall not be constructed so that a failure within the system does not prevent the normal stopping action from being applied to the press when required, but does prevent the initiation of a successive stroke until the failure is corrected. The failure shall be indicated by the system.
 - (d) Muting (bypassing of the protective function) of such device, during the upstroke of the press slide, is permitted for the purpose of parts ejection, circuit checking, and feeding.
 - (e) Refer to ANSI B11.19-2010 above for calculating safety light curtain distance from the point of operation.
 - (f) Guards shall be used to protect all areas of entry to the point of operation not protected by the presence sensing device.

1910.217 (C) (3) (iii)

Additional requirements for safeguarding

Where the operator feeds or removes parts by placing one or both hands in the point of operation, and a two hand control, presence sensing device or Type B gate or movable barrier (on a part revolution clutch), is used for safeguarding:



- (i) The employer shall use a control system and a brake monitor which comply with paragraphs (b) (13) and (14) of this section.
- (e) Inspection, maintenance, and modification of presses-
 - (i) It shall be the responsibility of the employer to establish and follow a program of periodic and regular inspections of his power presses to insure that all their parts, auxiliary equipment, and safeguards are in a safe operating condition and adjustment. The employer shall maintain records of these inspections and maintenance work performed.

1910.212

General requirements for all machines (covers press brakes, hydraulic and pneumatic machines not covered by mechanical power press standards).

- (a) Machine guarding - (1) Types of guarding. One or more methods of machine guarding shall be provided to protect the operator and other employees in the machine area from hazards such as those created by point of operation in going nip points, rotation parts, flying chips and sparks. Examples of guarding methods are: barrier guards, two-handed tripping devices, electronic safety devices, etc.

NOTE: These are only partial reprints, refer to your Federal Register for total construction, control reliability, and machine guarding requirements for the subject machine being guarded for all applicable OSHA Standards.

Machine Control Reliability
Requirements

Control Reliability:

“...control circuits shall be designed and constructed so that a single failure or fault within the system does not prevent the normal stopping action from being applied to the press when required, or does not create an unintended stroking action, but does prevent initiation of a successive stroke until the failure is corrected.” (ANSI B11.1-2009)

“...control shall be designed to prevent initiation of a stroke signal in the event that a failure occurs within the press control.” (ANSI B11.2-2013)

“Robots shall be designed and constructed so that any single, reasonably foreseeable failure will not cause hazardous motion of the robot.” (ANSI/RIA R15.06-2012)

“...control circuits shall incorporate features to minimize the possibility of an unintended stroke in the event of the failure of the control component to function properly, including relays, limit switches, and static output circuits.” (ANSI B11.1-2009)

“...control system shall be constructed so that a failure within the system does not prevent the normal stopping action from being applied to the press when required, but does prevent initiation of a successive stroke until the failure is corrected.” (ANSI B11.1-2009)

“...the control system shall be constructed so that a failure within the system does not prevent the normal stopping action from being applied to the press when required, but does prevent initiation of a successive stroke until the failure is corrected.” (OSHA CFR 1910.217)



Appendix B: Regulations and Guidelines Punch Press Control / Model 3200



Safety Guidelines for Management

Operational Safety

1. Appoint a Safety Coordinator to be responsible for safety regulations, requirements, and suggestions. He must review and investigate all accidents and "close calls."
2. Establish and issue safety rules. Inform each employee of his responsibilities. Make sure he understands them and knows what is expected of him.
3. A thorough review and an early inspection must be made of existing presses, dies, and point of operation guarding to attain the degree of responsibility required by ANSI B11.1-2009 Safety Standards and Federal State laws. Review what mandatory modifications are necessary.
4. Equipment that is no longer safe and cannot be economically upgraded should be destroyed.
5. Never allow persons legally under age to operate or assist in the operation of machinery.
6. All personnel must be properly trained to eliminate accidents and injuries.
7. Regardless of the operator's experience, education or language barrier, it is the responsibility of the supervisor to give him a thorough explanation with each new job assignment.
8. No employee should be given a work assignment that he does not fully understand. Only properly instructed and thoroughly trained personnel should be assigned to work on or with any machine.
9. It shall be the responsibility of the employer to provide an adequate, clean, safe, and uncluttered work area around each machine.
10. If a malfunction is reported, stop the machine immediately, correct the problem, then resume production.
11. Investigate all accidents and close calls. Analyze the reason for occurrence. Take action to prevent recurrences. Keep records of the investigation and preventative steps that were taken.
12. Only employees who understand the machines' operation and safety requirements and who are able to communicate this knowledge should be given the responsibility of instructing and training others to perform as operators.
13. Management must decide that personnel protective safety equipment is required to perform each job safely. Items such as safety glasses, shoes, gloves, helmets, hand pads, spats, protective sleeves, and material handling equipment are common in the metal working industry. If noise levels are excessive, protective head sets and ear muffs are recommended.
14. When designing point of operation guarding, the manufacturing process should be weighed heavily in favor of operational safety.
15. Establish safe and convenient material handling methods and procedures.
16. Post in convenient areas the names, addresses, and phone numbers of physicians and hospitals, and members of the organization who are to be called in case of emergency.
17. All equipment must be electrically connected according to the National Electric Code and be consistent with other accepted practices.
18. Provide adequate and proper fire protection equipment.



Power Press Guarding

1. Press manufacturers do not know and cannot foresee the magnitude of potential applications of power presses. Therefore, only the press user can determine the type of guards that have to be used in order to perform the job safely. It is the responsibility of the user management to make certain that point of operation guarding and other necessary safety devices are installed. The press should be guarded in such a manner that it is impossible for the operators to place their hands or any other part of the body in the die area.
2. The press user should become thoroughly acquainted with the safety devices commonly employed in power press operations.
3. Feeding devices are strongly recommended since they remove the operator from the die area and, therefore, allow more effective utilization of guards and safety devices.
4. Do not release a press for production before installing and testing all guards and covers.
5. Make frequent evaluation checks of all guarding and devices while the press is running. Correct all unsafe findings immediately.

Power Press Care Through Inspection and Maintenance

1. All maintenance and inspection personnel should be specifically instructed and must understand proper maintenance and inspection procedures contained in this manual.
2. Set up a daily, weekly, and monthly press inspection program. Use a checklist and verify that the job is done correctly.
3. Establish a preventative maintenance program. Records of all maintenance work performed must be kept.
4. Since all equipment has a limited life, quality maintenance personnel are required to obtain maximum usage of your equipment.
5. Releasing a power press for production following maintenance should be the responsibility of a qualified individual assigned by management.
6. To maintain the original level of press reliability, careful inspection of mechanical, electrical, and pneumatic areas must be made. This may give an advance warning of a hazard which then can

be corrected to prevent possible injuries and damage.

Safety Enforcement

In order to have an effective safety program, management at all levels must enforce every safety rule and regulation. Strong disciplinary measures are sometimes required. They should consist of a warning, written reprimand, work suspension, transfer, demotion, or possibly a dismissal. All infractions must be reported and recorded. Once an infraction is noted, it shows that an unsafe practice or condition has existed. This may be the result of poor planning or improper training and instructing. The reason for the infraction should be analyzed in order to take corrective action.

Supervisor Training

It should be the responsibility of management to instruct their supervisors on safety, giving job instructions, supervising operators, determining accident causes, and building safety attitudes among the machine operators. Accidents can occur due to inadequate training of supervisors.

Operator Training

It shall be the responsibility of management to insure proper training of operators. A specific training program should be instituted to instruct the operator in safety, proper usage of the equipment, and correct operational procedure in performing each and every job. In addition to the supervisor, the operator should be familiar with the proper guarding of the point of operation. Never permit an operator to start a job without complete instructions from his immediate supervisor.



Appendix C:

Drawings

Punch Press Control / Model 3200

Circuit Board Dimensional Layout

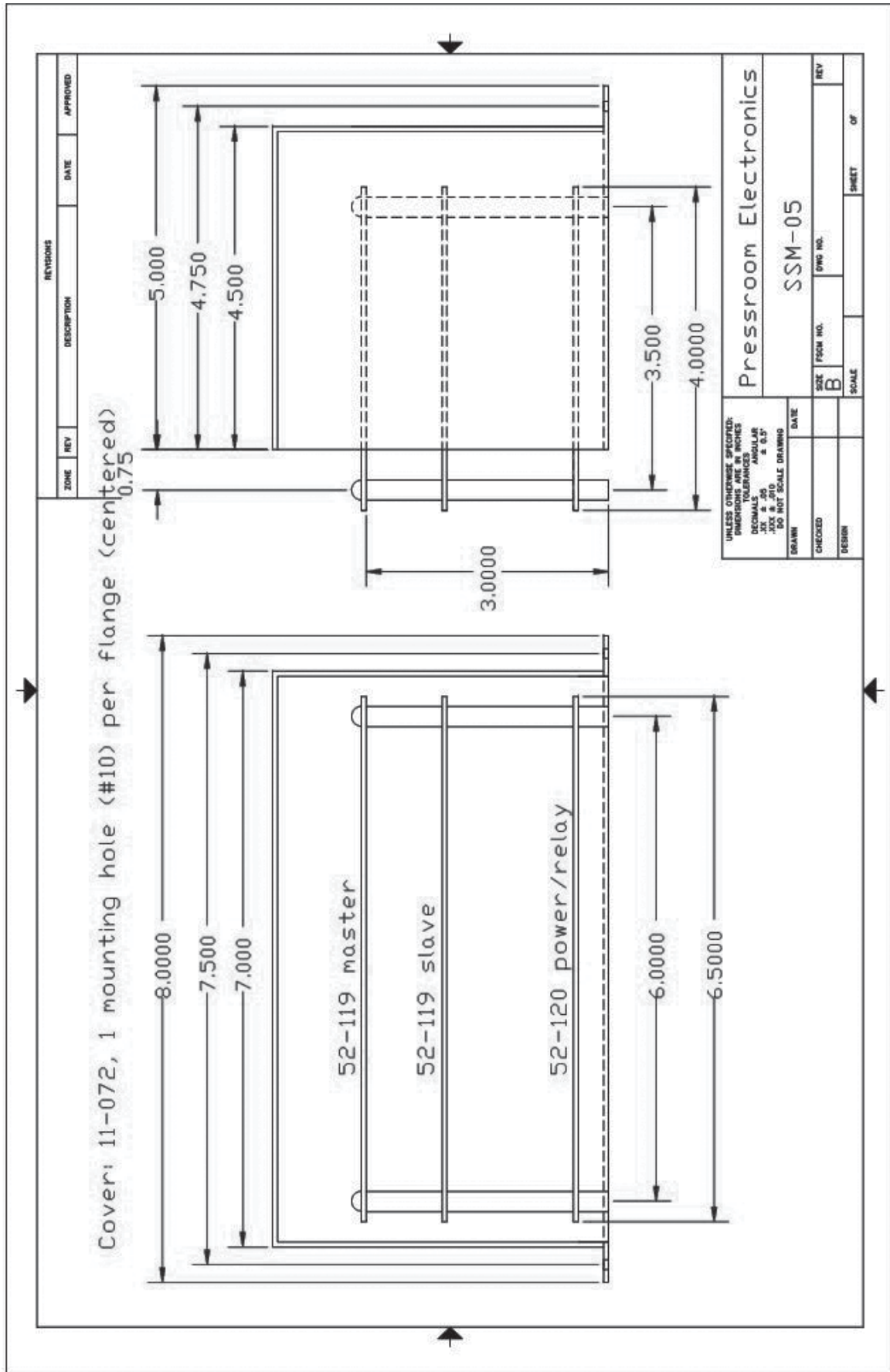

⚠WARNING You must use Dual Safety Valves. Please refer to the front of this manual, "Warning on Actuating Press Valves" for detailed requirements.

Appendix C: Drawings IEC Control Wiring Diagrams Punch Press Control / Model 3200

MASTER BOARD

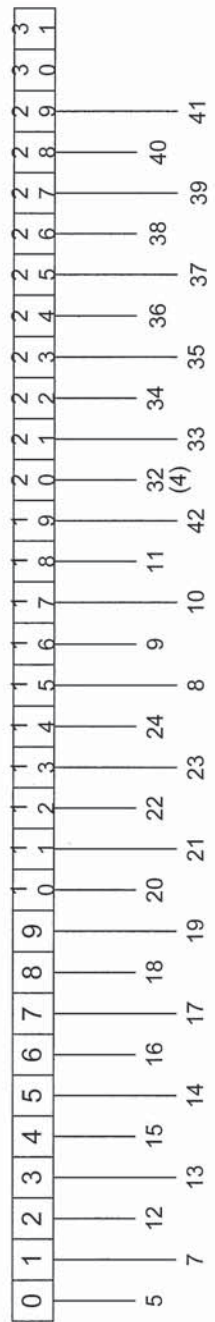

SLAVE BOARD

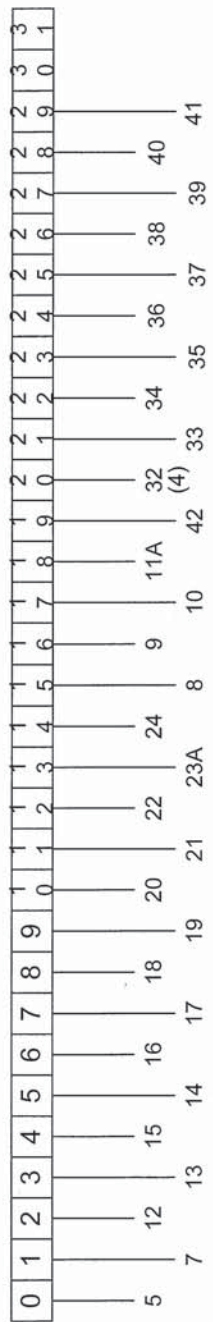

POWER SUPPLY BOARD

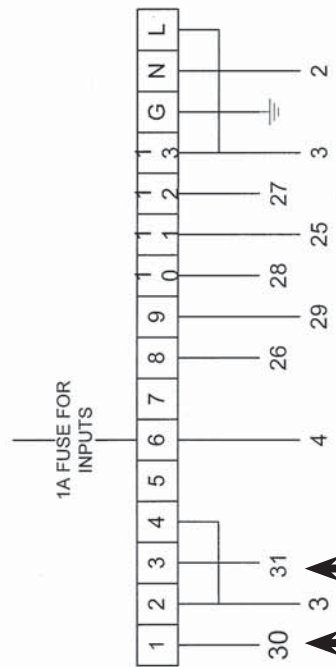

IF ONLY 1 OPER STA IS USED
WIRE INPUT 20 TO TERM #4

MARCH 2011			PRESSROOM ELECTRONICS		
42004/5 R71			3200SS		
SIZE	FSCM NO	DWG NO	REV		
42004/5 R71		3101A			
SCALE	1:1	SHEET	1		

⚠WARNING You must use Dual Safety Valves. Please refer to the front of this manual, "Warning on Actuating Press Valves" for detailed requirements.

Appendix C:
 Drawings
 IEC Control Wiring Diagrams
 Punch Press Control / Model 3200

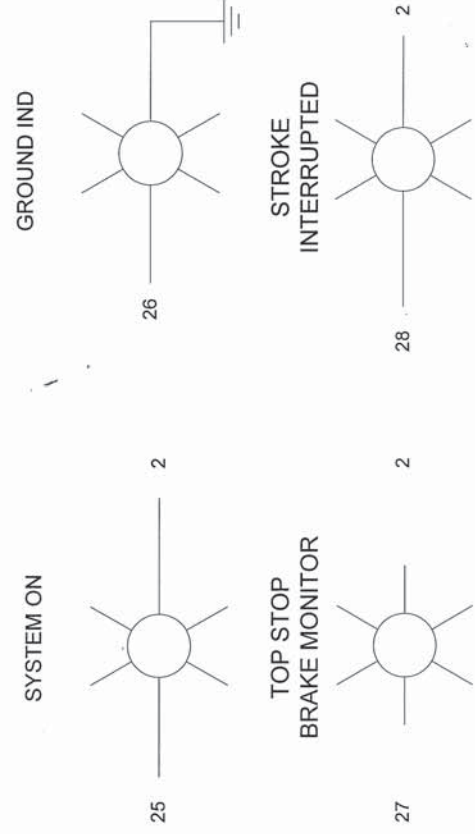
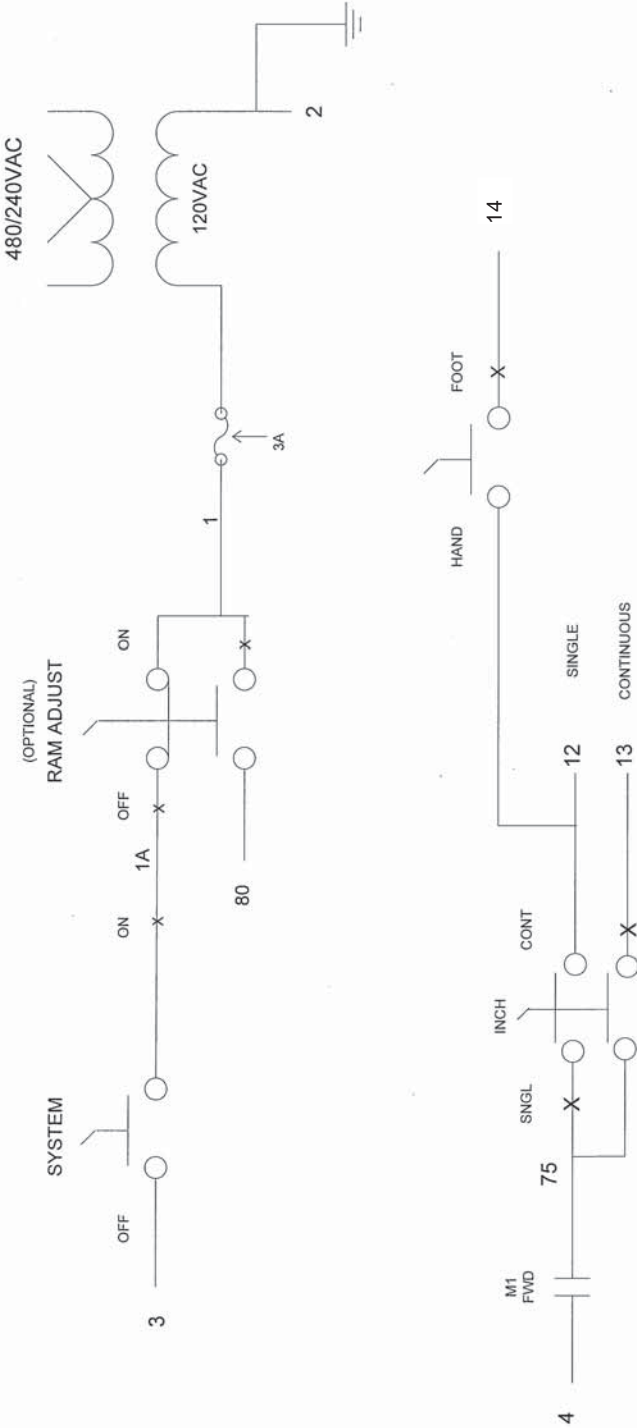

MARCH 2011		PRESSROOM ELECTRONICS	
3200SS PUNCH PRESS CONTROL			
SIZE	FSCM NO	DWG NO	REV
42004/5 R71		3101B	
SCA	I.F.	SHE	LET
	1:1		2

Appendix C: Drawings IEC Control Wiring Diagrams Punch Press Control / Model 3200

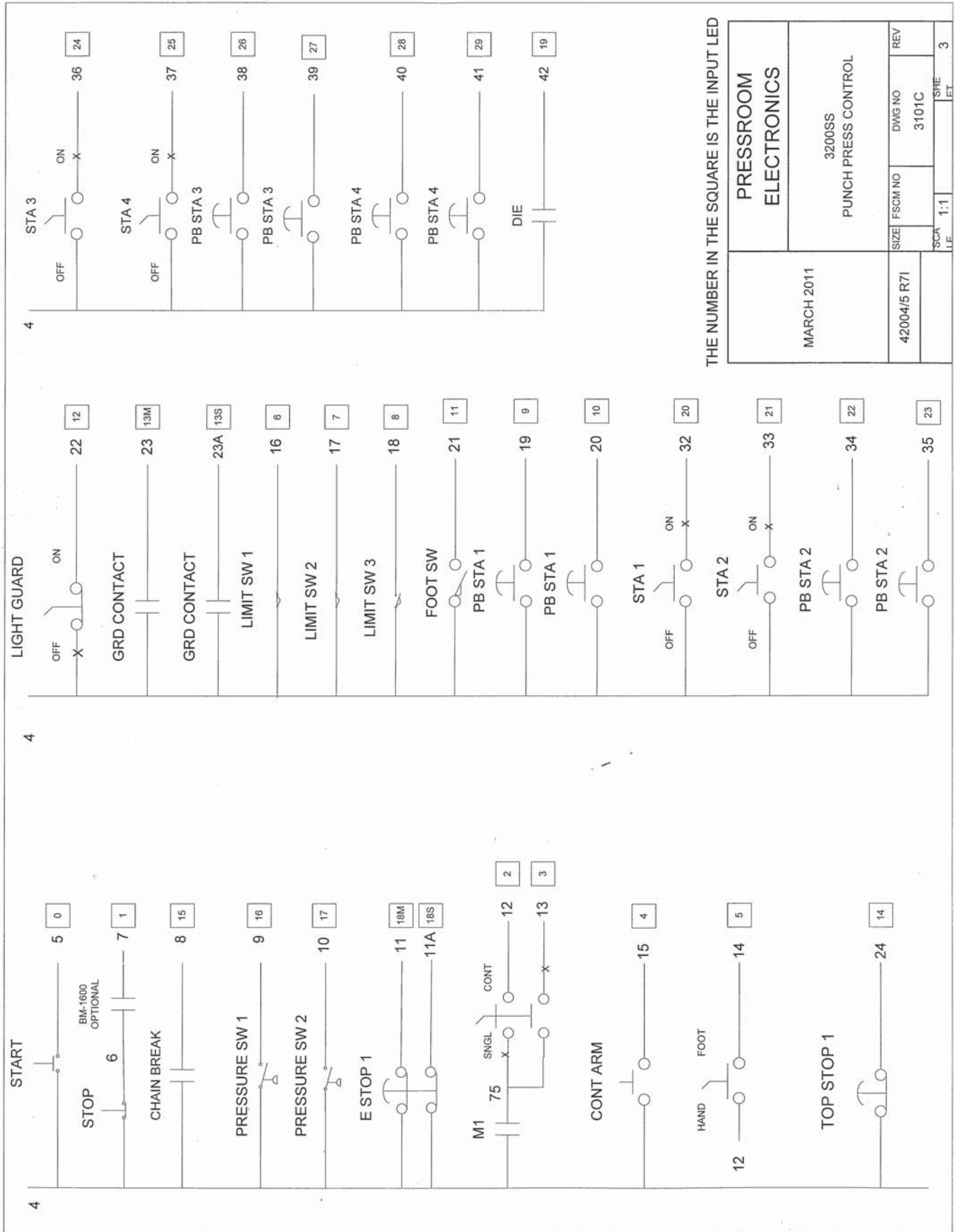

Appendix C: Drawings IEC Control Wiring Diagrams Punch Press Control / Model 3200

WARNING You must use Dual Safety Valves. Please refer to the front of this manual, "Warning on Actuating Press Valves" for detailed requirements.

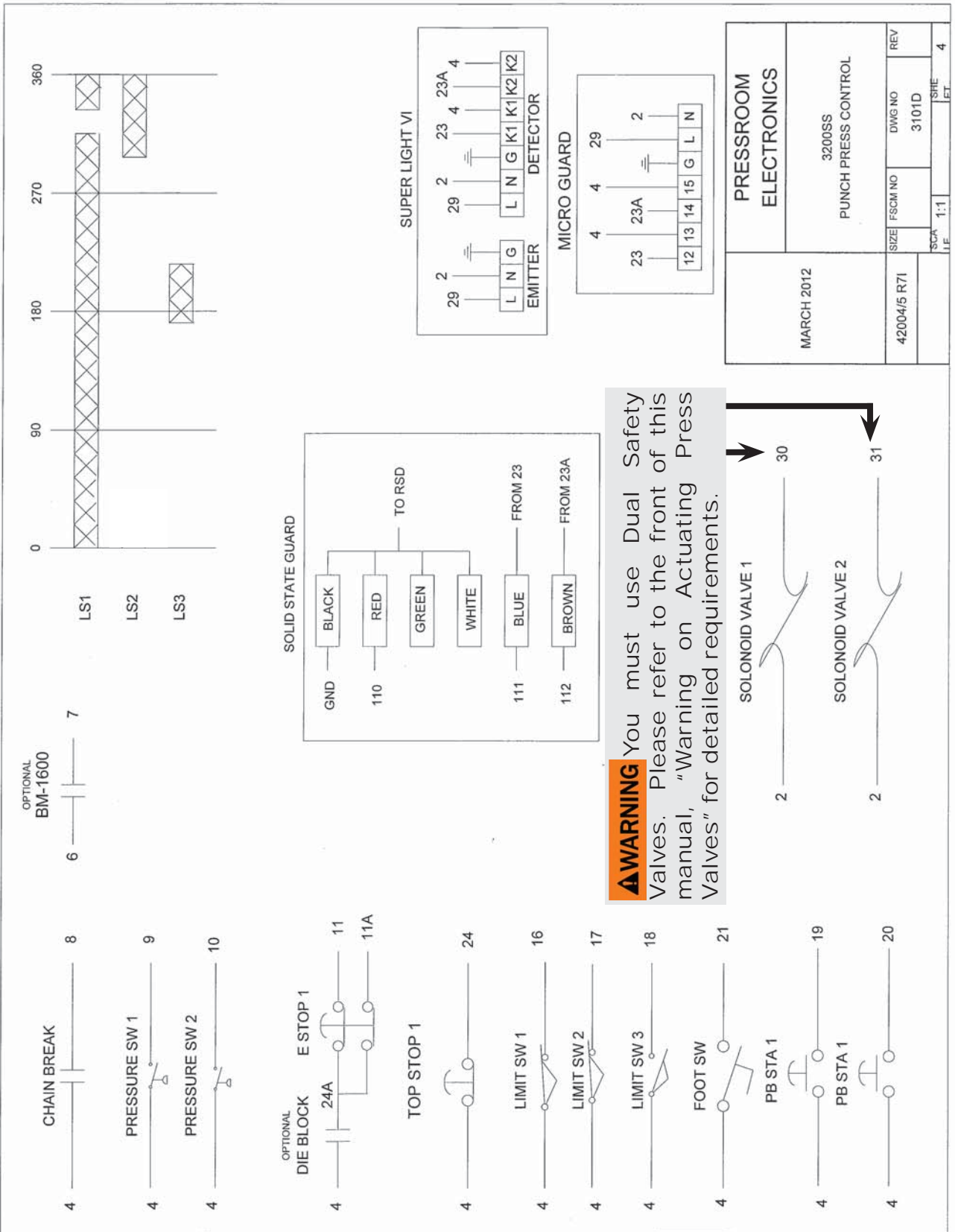

Appendix C: Drawings NEMA Style Switch Gear Punch Press Control / Model 3200

NEMA STYLE SWITCH
GEAR FOR CONTROLS
W/ SERIAL NUMBERS
BEGINNING WITH #11

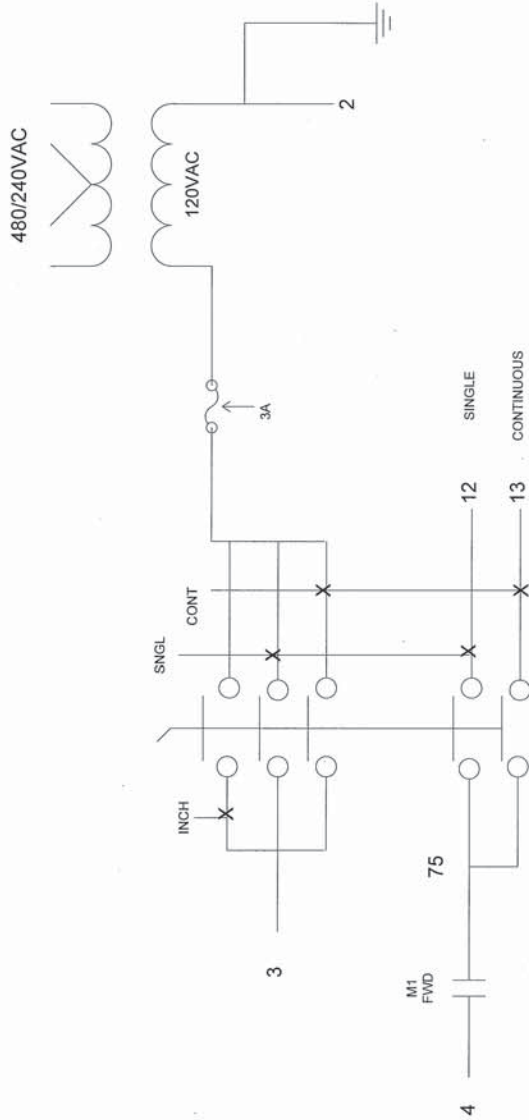

MARCH 2011	PRESSROOM ELECTRONICS		
42004/5 R71	3200SS PUNCH PRESS CONTROL		
SIZE	FSCM NO	DWG NO	REV
4	3	3101E	1
SCA	1:1	TSHE	LET

Appendix C:
 Drawings
 NEMA Style Switch Gear
 Punch Press Control / Model 3200

NEMA STYLE SWITCH GEAR
 FOR CONTROLS W/ SERIAL
 NUMBERS BEGINNING WITH #10 OR LESS

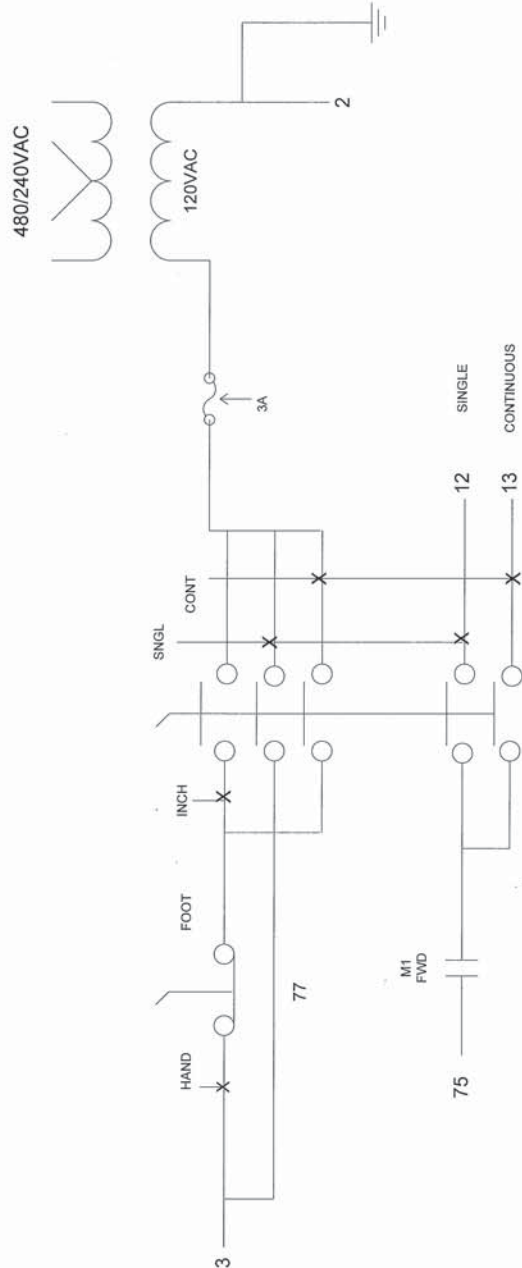

MARCH 2011		PRESSROOM ELECTRONICS	
3200SS PUNCH PRESS CONTROL			
SIZE	FSCM NO	DWG NO	REV
		3101F	
SCA	1:1	TSHE	LET

WARRANTY

Manufacturer warrants that this product will be free from defects in material and workmanship for a period of one year from the date of shipment thereof. Within the warranty period, manufacturer will repair or replace such products which are returned to it with shipping charges prepaid and which will be disclosed as defective upon examination by the manufacturer. This warranty will not apply to any product which will have been subject to misuse, negligence, accident, restriction, and use not in accordance with manufacturer's instructions or which will have been altered or repaired by persons other than the authorized agent or employees of the manufacturer.

DISCLAIMER

The provisions of the paragraph "Warranty" are the sole obligations of the manufacturer and exclude all other warranties of merchantability, expressed or implied. Further, there are no warranties which extend beyond the above warranty.

DISCLAIMER

Pressroom Electronics does not assume liability for the contents of this publication or the use of any products described. Pressroom Electronics reserves the right to make changes to the products or any catalogs without further notice.

ERRORS AND OMISSIONS

Information presented by Pressroom Electronics has been checked and is believed to be accurate; however, no responsibility is assumed for clerical, typographical or proofreading errors or omissions.

LIMITATION OF LIABILITY

In the event of any claim or breach of any obligations of manufacturer under any order, whether expressed or implied, and particularly in the event of any claim or a breach of the warranty or warranties contained in the paragraph "Warranty" or of any other warranties, expressed or implied which might, despite the paragraph entitled "Disclaimer," be determined to be incorporated in any order, the company shall under no circumstances be liable for any consequential or special damages, either in law or in equity, or for losses or expenses or claims for the same arising from the use of, or inability to use, the products of the manufacturer for any purpose whatsoever.

WARNING

The entire machine safety system must be tested at the start of every shift. Machine testing should include: (1) proper machine operation and stopping capability; and (2) verification of proper installation and settings of all point of operation guards and devices before the operation is released for production.

CHANGE IN SPECIFICATIONS

Product specifications and accessories may be changed at any time based on improvements and other reasons. It is our practice to change part numbers when published ratings or features are changed, or when significant construction changes are made. However, some specifications of the Product may be changed without any notice. When in doubt, special part numbers may be reassigned to fix or establish key specifications for your application. Please consult the factory.



Pressroom *Electronics*™

Sales and Marketing Offices

United States

Pressroom Electronics, Inc.
P.O. Box 99875
Pittsburgh, PA 15233
Toll Free: 800-937-4334
Direct: 412-262-1115
Fax: 412-262-1197

Canada

Pressroom Electronics, Inc.
8-1734 Orangebrook Court
Pickering, Ontario L1W 3G8
Toll Free: 888-285-8885
Direct: 905-831-1111
Fax: 905-831-4064

Customer Service (630) 443-9320

We have designed our equipment to the very highest performance and safety standards known to the current technological state of the art, as evidenced by our U.S.A. and foreign patents issued and pending. However, the installation, usage, suitability, and fitness of our equipment for any purpose, known or unknown, is interdependent upon the performance of other equipment not manufactured, installed, secured or maintained by Pressroom Electronics, Inc.

We cannot and do not accept responsibility for any overall system performance when factors, such as these, are beyond our control.

www.pressroomelectronics.com

sales@pressroomelectronics.com
service@pressroomelectronics.com