

Metal Stamping/Metal Forming Industry Products

- Punch Press Clutch/Brake & Automation Controls
- Pneumatic & Hydraulic Control Systems
- Production Monitoring to Create OEE
- Machine Safeguarding Systems



Complies with OSHA & ANSI
and International Design Standards

www.pressroomelectronics.com

Distributor Manual

Table of Contents

Pressroom Electronics Catalog

Pressroom Electronics Products Overview	iii-vii
Resolver Based “PressCommander” (PCS) Platform of Press Controls.....	iii
Rotary Cam Based Platform of Press Controls.....	iv
Punch Press Automation Control Products.....	v
Pressroom Electronics Products by Category and Function.....	vi
Punch Press Controls Advanced Design Criteria Descriptive Writing	vii
Resolver Based Punch Press Controls Section “PressCommander” (PCS)	A1-A29
PressCommander Standard Features.....	A2
PressCommander Options.....	A3-A5
PressCommander Touchscreen (optional).....	A6
Operator Screen.....	A7 and A9
Production / Downtime Monitoring Definitions.....	A8
Die Protection / PLS (Programmable Limit Switch).....	A10
Servo Control / Tonnage Monitoring Screen.....	A11
Press Set-up Screen.....	A12
Fault Message Screen.....	A13
Downtime Monitoring Screens.....	A14-A15
Production and Downtime Monitoring Features, Benefits and Implementation.....	A16-A17
Touchscreen Cutout Pattern.....	A18
PressCommander Standard Control (1-500 SPM).....	A19
PressCommander High Speed Control (+500 SPM).....	A20
Various PressCommander Models Available.....	A21-A23
PressCommander Proposal / Ordering Guide.....	A24-A28
PressCommander Replacement Parts.....	A29
Custom Programming & Remote Field Upgrades	A30
Rotary Cam Based Punch Press Controls	B1-B9
Options for Rotary Cam Based Punch Press Controls.....	B6
Replacement Parts for Rotary Cam Based Punch Press Controls.....	B7
Ordering Guide for Rotary Cam Based Punch Press Control.....	B8-B9
Time Based Brake Monitor – Time Based Linear Stopping Performance Monitors	C1-C14
Model BM-1600 Time Based Brake Monitor (Rotary Encoder Based).....	C3-C7
Model LT-1900 Time Based Linear Stopping Performance Monitor (Linear Transducer Based)....	C9-C13
Punch Press Automation Controllers – PressCam 8 Junior and PressCam 8	D1-D19
Feature Comparison of PressCam 8 Junior and PressCam 8.....	D2
PressCam 8 Junior.....	D3-D9
PressCam 8.....	D10-D19

Table of Contents

Pressroom Electronics Catalog

Model FPC Control System - Open Architecture Multi-Function Machine Controls for Fluid Power Safety of Hydraulic or Pneumatic Energy Based Machines.....	E1-E3
3200SS Clutch/Brake Control with PressCam 8 Built-In.....	F1-F2
The Ultimate	F2
Components, Valves, Main Power Disconnects and Magnetic Motor Starters.....	G1-G6
Components for the Metal Stamping / Metal Fabrication Industry	G1
Punch Press Control System Components	G2-G3
Dual Safety Air Valves for Punch Presses.....	G4
IEC Style – Main Power Disconnects and Magnetic Motor Starters.....	G5
NEMA Style – Main Power Disconnects and Magnetic Motor Starters.....	G6
Die Protection Sensor Interface.....	H1
Machine Safeguarding Products 	Last Page

Pressroom Electronics Products Overview

Resolver Based “PressCommander” Platform Press Controls

PressCommander PCS-2000



Exceeds OSHA 1910.217 & ANSI B11.1-2009, “Control Reliable Design,” with dual logic power supplies, heavy duty resolver and cable, System diagnostics and programming in plain English/Spanish which can control up to four sets of operator stations, Major faults such as E-Stop, motion, brake monitor, and sensor faults are handled by two force-guided relays (Form B safety relays), Off--inch--single--continuous, Continuous ARM; top stop, anti-tie down and anti-repeat, SPM Range (1 to 500), Password and supervisory controlled keyed selector switch for security of data entry, Interrupted stroke provision with indicator, Inch mode monitoring, Crank angle and speed readout (SPM), Time-based brake monitor, Built-in motion detector and drift fault, 90° and 270° stop time tester/meter built-in, Built-in hour meter for maintenance, Built-in variable speed compensation, Servo-feed interface built-in, Six optically isolated die protection inputs, Six PLS (programmable limit switch) output relays, 100 job memory, Stroke, batch, quality, and part counters, Batch counter output relay, Die protection output relay, Speed output relay, Auxiliary output relay, Optional Ethernet or DeviceNet and PC Link to allow offline job creation and storage. (For Custom Programming & Remote Field Upgrades, please consult factory at service@pressroomelectronics.com or (630) 443-9320.) Optional 10.1” color touchscreen replaces the standard display shown. Touchscreen is shown to the left and includes Production Monitoring.

Various Available PressCommander Formats (All include features listed above)

PCS-05 / PCS-08



Switches, push buttons and legend plates available with PCS-08 only.

The Board Only PressCommander Module (Part #PCS-05). The redundant clutch/brake punch press control module with a remote panel mount message display (available in English or Spanish).

The PCS-08 includes the same options as the PCS-05, but also includes the IEC switches, push buttons and legend plates.

Both models comply with section 1910.217 of the Federal Register and ANSI Standard B11.1-2009.

PCS-10



The compact Model PCS-10 is big in safety and automation control. The redundant clutch/brake punch press control module has a remote panel mount message display (available in English or Spanish). Complies with section 1910.217 of the Federal Register and ANSI Standard B11.1-2009.

PCS-20



Encompasses all of the features and components of Model PCS-10 plus all of the switches, legend plates, push buttons, and indicator lights for easy mounting into your existing control. Complies with section 1910.217 of the Federal Register and ANSI Standard B11.1-2009.

PCS-4000



Incorporates all the requirements of OSHA for control reliability and component monitoring. Also includes component and system diagnostics with indicator lights for total press monitoring. When foot actuation is used, a method of guarding the point of operation must be provided. Complies with section 1910.217 of the Federal Register and ANSI Standard B11.1-2009.

***Optional:** 10.1” color touchscreen replaces the standard display and is available for all models.

Pressroom Electronics Products Overview

Rotary Cam Based Platform of Press Controls

Model 3200SS



The Model 3200SS (Solid State) Control System is completely prewired and ready for installation. System supplied complete with a well marked terminal strip for easy, safe, and accurate electrical interface to the various punch press components. Due to the hybrid design characteristics of the 3200SS, a main power disconnect switch and magnetic motor starters can be supplied in the same control panel. Complies with section 1910.217 of the Federal Register and ANSI Standard B11.1-2009.

SSM-05 / SSM-08



The Board Only Clutch/Brake Module (Part #SSM-05). The redundant clutch/brake punch press control module with a remote panel mount message display (available in English or Spanish diagnostics).

The SSM-08 includes the same options as the SSM-05, but also includes the IEC switches, push buttons and legend plates.

Both models comply with section 1910.217 of the Federal Register and ANSI Standard B11.1-2009.

Switches, push buttons and legend plates available with SSM-08 only.

SSM-10



Excellent for the Rebuilder or O.E.M. to install onto existing control panel backplate. The Short Stack Module (Part #SSM-10) is Small in Size -- Big in Safety and Control. The redundant clutch/brake punch press control module has a remote panel mount message display (available in English or Spanish diagnostics). Complies with section 1910.217 of the Federal Register and ANSI Standard B11.1-2009.

SSM-20



The Short Stack Plus (Part #SSM-20) encompasses all of the features and components of Part #SSM-10 plus all of the switches, legend plates, push buttons, and indicator lights for easy mounting into your existing control panel. The redundant clutch/brake punch press control module has a remote panel mount message display (available in English or Spanish diagnostics). Complies with section 1910.217 of the Federal Register and ANSI Standard B11.1-2009.

1500SS



Model 3200SS (Solid State) Control System with Components Included. Mounted in a NEMA 12 (IP 64) steel panel enclosure. Complies with section 1910.217 of the Federal Register and ANSI Standard B11.1-2009.

1500SS Package includes the following components:

- Dual Solenoid Valve
- Operator Station
- Heavy Duty Pressure switch No. 306
- Filter Regulator Lubricator No. 311
- Rotary Cam Switch with Drive Check No. 310A

*Please note that when punch press timing signals are generated by Rotary Cam or Limit Switches, it is required to have a "time based brake monitor." The time based brake monitor is to measure the press stopping time on each stroke. If the subject press that is being updated with controls does not have a time based brake monitor, add the Model BM-1600 Time Based Brake Monitor to the press control.

(For Custom Programming & Remote Field Upgrades, please consult factory at service@pressroomelectronics.com or (630) 443-9320.)

Pressroom Electronics Products Overview

Punch Press Automation Products

The Ultimate



The most feature intensive air clutch punch press control available. The control conforms to all current OSHA and ANSI standards for control reliability and component monitoring. System incorporates the PressCam 8 for complete punch press synchronization and flexibility for all peripheral punch press signaling needs such as feeds, die protection, lubrication, blow-offs, etc. All of the electrical timing adjustments for the complete press operation are done at the floor level by the operator. The PressCam 8 system also has a large job memory of 100. This gives the control the ability to remember 100 complete different jobs or die set-ups at the press. The memory concept at the press is an excellent feature due to the tremendous time saved during set-ups of various operations. Additional time is saved by being able to adjust or "fine tune" the stamping process while the press is running, which is an aid in maximizing press utilization.

BM-1600



The BM-1600 is a time-based brake monitor that utilizes a high resolution rotary encoder and controller to measure the brake stopping time in milliseconds and also the RPM of the press. The rotary encoder is attached to the subject machine and is driven on a 1:1 ratio by the power press crankshaft. The brake stopping time of the machine will be displayed on every stop and can be easily read on the bright red light emitting diode (LED) display on the front panel of the unit. The RPM/ of the machine will be displayed during the machine cycle.

LT-1900



The LT-1900 is a time-based stopping performance monitor that utilizes a high resolution linear transducer and controller to measure the machine stopping time in milliseconds and also the SPM of the press. The linear transducer is attached to the subject machine and is driven on a 1:1 linear ratio by the machine. The machine stopping time of the machine will be displayed on every stop and can be easily read on the bright red light emitting diode (LED) display on the front panel of the unit. The SPM of the machine will be displayed during the machine cycle.

PressCam 8



PressCam 8 is a "control reliable" resolver based programmable cam switch (PLS), time-based brake monitor, die protection system, multiple counters, and much more in one package. The system contains two 16-bit computers that are configured to cross check each other and the resolver. The dual computers are interfaced with a full view 8" (203mm) diagonal LCD computer screen for viewing and programming ease. This large operator screen supplies operators and front line supervisors production data without the need of cumbersome menu and program access codes. 100 job memory.

PressCam 8 Junior



The PressCam 8 Junior is a resolver-based press automation controller that incorporates a programmable cam limit switch (PLS), timed-based brake monitor, servo feed control, four counters, and a die protection system. The PressCam 8 Junior is controlled by a 16-bit computer that constantly checks the resolver for accuracy. 100 job memory.

Remote Die Box



The six (6) channel remote die box allows you to quickly change out the die sensors by using either plug connectors or Banana jacks. Provides +24VDC power to active sensors and monitors the status (PNP or NPN). Part number 53-450 six (6) channel Remote Die Box includes individual channel indicators, 45' quick disconnect cable (12 conductor) minimizes wiring installation time and power supply included to power sensors - 24VDC at 2.5 AMP.

Pressroom Electronics Products by Category and Function

Resolver Based Clutch/ Brake Controls with Automation Functions

- PressCommander (PCS)
- Small Form Package PressCommander
- PCS-05
- PCS-08
- PCS-10
- PCS-20
- PCS-2000
- PCS-4000
- The Ultimate
- Optional 10.1" color touchscreen display is available for all PCS models and replaces the standard display.

Punch Press Automation Controllers (Resolver Based)

- PressCommander
- PressCam 8
- PressCam 8 Junior

Time Based Brake Monitor (Rotary Based)

- BM-1600
- PressCommander (PCS)
- PressCam 8
- PressCam 8 Junior

Time Based Stopping Performance Monitor (Linear Based)

- LT-1900

Programmable Limit Switches (PLS), Timers, Counters

- PressCommander (PCS)
- PressCam 8
- PressCam 8 Junior

Shut Height Indicator

- PressCommander (PCS)

Die Protection Systems

- PressCommander (PCS)
- PressCam 8
- PressCam 8 Junior
- Die Protection Sensor Interface Remote Die Box

Servo Feed Interface

- PressCommander (PCS)
- PressCam 8
- PressCam 8 Junior

Tonnage Monitoring

- PressCommander (PCS)
- PressCam 8

Signature Tonnage Analysis

- Requires PressCommander (PCS) with Touchscreen and signature tonnage option.

Production / Downtime Monitoring

- Requires PressCommander (PCS) with Touchscreen option for generating OEE (Overall Equipment Efficiency.)

Rotary Cam Based Clutch/ Brake Controls

- Model 3200SS
- SSM-05
- SSM-08
- SSM-10
- SSM-20
- Control Package 1500SS

Punch Press Controls

Advanced Design Criteria

Safer, More Productive and Easier to Use

The following descriptive writing is the base design criteria for the Pressroom Electronics' punch press control systems. The inherent design features are superb for enhancing production and safety. Please note that options are available within each individual system or package to aid in production.

DESIGN CRITERIA—Complete self-checking dual logic microprocessor-based punch press control with two independent running control channels and a comparison circuit. The comparison circuit assures that both channels agree as the punch press control sequence occurs. The preprogrammed dedicated inelastic control system prevents in field alterations to the safety features of the control. The control incorporates a control reliable redundant design concept to assure a higher level of safety and reliability.

CONTROL RELIABILITY "CONTROL COMPONENT FAILURE"—The Pressroom Electronics' Punch Press Control meets or exceeds all OSHA 1910.217 and ANSI B11.1-2009 standards for control reliability. Control reliability standards require that clutch/brake circuits be designed and constructed so that a single failure or fault within the system does not prevent the normal stopping action from being applied to the press when required, or does not create an unintended stroking action, but does prevent initiation of a successive stroke until the failure is corrected.

REDUNDANT DESIGN CONCEPT—The Punch Press Control system utilizes the redundant design concept. This gives the clutch/brake control system a higher level of redundancy and control reliability.

DIAGNOSTIC MESSAGE DISPLAY—Standard on the solid state Pressroom Electronics' Punch Press Control System is the "Diagnostic Message Display" mounted with the operator controls at a customer designated location on the control panel. The alphanumeric message display informs the user of any faults, failures, and the current operating status of the punch press control system. The messages are in plain English and will give the press operator and front line supervisor information quickly and safely. The "Diagnostic Message Display" system is so advanced that it will immediately inform the user of such problems as pressure switch faults, failed output relays, or rotary cam mis-adjustment. The system will also pinpoint internal printed circuit board faults for immediate replacement. This self-diagnostic feature will save maintenance dollars and will enhance machine uptime measurably due to the units captive troubleshooting ability. Best of all, this information is supplied without even opening the control panel door. Additionally, a complete series of LED's (light emitting diodes) are mounted on the clutch/brake module for visual status of all inputs and outputs related to the machine cycle status.

Optional: 10.1" color touchscreen replaces the standard display and is available for all models.

SYSTEM LOGIC AND COMPONENT DIAGNOSTICS—A combination of LED's and the alphanumeric plain English message display will enhance infield troubleshooting greatly. The advanced design can even troubleshoot itself and advise the user if a printed circuit board is defective and if it needs to be replaced or repaired. Diagnostics are for both the control system logic and for punch press component monitoring. Twenty-nine different messages can appear on the message display.

REDUNDANT CAPTIVE CONTACT SAFETY RELAYS—Redundant relays assure safety if an output relay should fail. The system utilizes safety relays which have forceguided contacts. This is a configuration where the contacts are mechanically locked together so that if one set of contacts weld, the other contacts cannot change state. If one should fail, the message display will identify which relay has faulted and what state the relay should be in (on/off).

MICROPROCESSOR DESIGN OF SOLID STATE PUNCH PRESS CONTROLS—Incorporates "cross checking, self-checking, and redundancy" (to assure an ultra-safe design) with control reliability.

INTERRUPTED STROKE PROVISIONS WITH INDICATOR—If the punch press is in the "single stroke" or "continuous" mode and the press stops before the completion of a full stroke, the Interrupted Stroke Provision is activated. The control will automatically switch to the "inch" mode and the palm buttons must be used to return the ram to the top of the stroke. When back at the top, the control automatically switches back to the original operational mode setting and the operator may resume normal production. The Interrupted Stroke Provision improves productivity and safety significantly by eliminating the need for the operator to make mode selection adjustments on interrupted strokes.

MICRO-INCH (OPTIONAL)—Controlled by keyed selector switch on/off on the control panel, Micro-Inch provides ram movement for a predetermined amount of time. Micro-Inch is actuated by the palm buttons and the amount of ram movement is controlled by a Micro-Inch timer inside the control panel. Micro-Inch also indexes the ram in increments that eases set-up in high speed or short stroke press operations.

AUTOMATIC EXTERNAL TRIP (OPTIONAL)—Controlled by a keyed selector switch (on/off) on the control panel. This option enables a punch press to be cycled by a signal from a robot or feeding device one stroke at a time.

Resolver Based Punch Press Controls

Operator controls & Punch Press Automation
functions that are completely
integrated and supplied standard
with clutch/brake control.

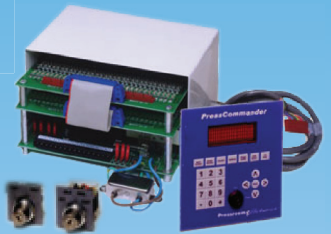
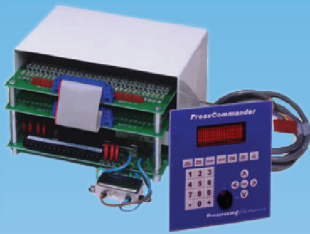
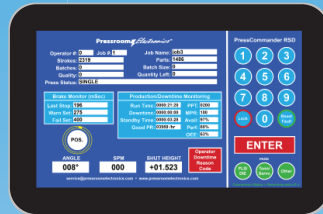

Pressroom  *Electronics*™

The Resolver Based PressCommander Clutch/ Brake OSHA Control with Complete Press Automation Built-In (shown with Standard Display)



**The User Friendly
PressCommander™**
(shown above with Standard Display)
Available in any control
panel layout or retrofits
easily into an existing control panel.

Standard Safety / Automation Features:

- Exceeds OSHA 1910.217 & ANSI B11.1-2009
- Quick and Easy Installation
- Control Reliable Design (Triple CPU Redundancy)
- Incorporates dual logic power supplies
- Heavy duty resolver with self-checking input on every press cycle with 30' of resolver cabling supplied standard
- Complete system diagnostics and programming in plain English/Spanish by a four line by twenty character vacuum fluorescent display
- Optional: 10.1" color touchscreen display replaces the standard display shown.
- Can control up to four sets of operator stations
- Operates at 24VDC, 110VAC, or 240VAC / 440VAC
- Major faults such as E-Stop, motion, brake monitor, and sensor faults are handled by two force-guided relays (Form B safety relays)
- Modes of operation: off--inch--single--continuous
- Continuous ARM; top stop, anti-tie down and anti-repeat
- System start/stop functions
- SPM Range -1 to 500
- Password and supervisory controlled keyed selector switch for security of data entry
- Interrupted stroke provision with indicator
- Inch mode monitoring
- Crank angle and speed readout (SPM)
- Time-based brake monitor

- Built-in motion detector and drift fault
- 90° and 270° stop time tester/meter built-in
- Built-in variable speed compensation
- Servo-feed interface built-in
- Six optically isolated die protection inputs that can be either AC or DC (sourcing or sinking) (Expandable)
- Six limit switch outputs can be set to cycle (non-timed) two times per crank rotation by setting an open/close crank angle (Expandable)
- The last three limit switch outputs can be set for timed, non-timed, delay, hold, or cycle two times per crank revolution.
- Six PLS (programmable limit switch) output relays are small, high speed, and high capacity. These outputs can be controlled by the press crank angle position, dwell time, number of strokes or any combination of the above. (Expandable)
- Optional "Expander" board provides an additional six Die Inputs and six Programmable Outputs.
- 100 job memory (removable)
- Stroke, batch, quality, and part counters
- Batch counter output relay
- Die protection output relay (opens when there is a fault)
- Speed output relay (opens when press speed falls out of the max/min parameters)
- Auxiliary output relay (customer assigned usage)
- Optional Ethernet or CAN network
- Remote monitoring with Ethernet
- PC Link to allow offline job creation and storage
- Optional Tonnage Monitoring
- Two-year warranty
- Made in the USA

Optional - 10.1" Touchscreen replaces Standard Display shown above left. Includes Production Monitoring to create OEE.

Pressroom Electronics			PressCommander RSD		
Operator #:	Job #:	Job Name:	1	2	3
Strokes:	Parts:		4	5	6
Batches:	Batch Size:		7	8	9
Quality:	Quantity Left:		Lock	0	Reset Fault
Press Status:			ENTER		
Brake Monitor (mSec) Last Stop: _____ Warn Set: _____ Fail Set: _____		Production/Downtime Monitoring Run Time: _____ PPT: _____ Downtime: _____ MPR: _____ Standby Time: _____ Avail: _____ Good PR: _____ Perf: _____ OEE: _____			
POS. ANGLE SPM SHUT HEIGHT		Operator Downtime Reason Code PLS/ DIE Tonn/ Servo Other			
<small>service@pressroomelectronics.com • www.pressroomelectronics.com</small>					

(For Custom Programming & Remote Field Upgrades, please consult factory at service@pressroomelectronics.com or (630) 443-9320.)

PressCommander Options - Resolver Based

Utilizes the Standard Display

Additional Die Protection Inputs and PLS (programmable limit switch outputs)

Expander Board #52-279 adds additional 6 Die inputs and 6 Dry relay contact outputs (At time of order) - Increases the PressCommander die protection from six (6) to twelve (12) station die protection. Also increases the PressCommander programmable limit switch capacity from six (6) to twelve (12) programmable limit switches with mechanical relay (dry) outputs.

Expander power supply board #52-280 (At time of order) - Power Supply Board that stacks under the PressCommander Expander Board (52-279) and is required to power the Expander Board functions.
Request Both Part Numbers (52-279 and 52-280) at time of order if expansion is desired.

Main Power Disconnects

Fused main power Disconnect (IEC or NEMA)

Refer to *Component* section of this catalog for voltage, sizing and part numbers for starters and main power disconnects.

Magnetic Motor Starters

Magnetic Motor Starters are available in IEC or NEMA design formats

Fwd/Rev switchgear with Motor start/stop pushbuttons and legend plates included with Reversing Starter purchase.

Motor start/stop pushbutton and legend plate included with Non-Reversing Starter purchase.

Refer to Component section of this catalog for voltage, sizing and part numbers of the appropriate size starter.

Remote Master Control Station (Free standing operator control station) PressCommander Standard Display Extender System.

Moves all the switchgear and the standard display unit into a separate 12" x 14" x 8" box that can be placed closer to the operator. The control boards, optional starter(s), optional disconnect remain in a separate Control panel whose size is dictated by the size of the starter(s) & disconnect.

NOTE: Cables are available in 15', 25', 35', and 50' lengths. These cables should never be cut between the Remote Master Control Station and Control panel. 15' cable is supplied standard for the Standard Display remote mater control station.

Extension Cables for Remote Master Control Stations located over 15' (4.5m) with Standard Display from control panel.

Part# 53-456 is a 25' Remote Standard Display Extender System (when the Standard Display unit is located 25' from the PressCommander Board Stack)

Part# 53-457 is a 35' Remote Standard Display Extender System (when the Standard Display unit is located 35' from the PressCommander Board Stack)

Part# 53-458 is a 50' Remote Standard Display Extender System (when the Standard Display unit is located 50' from the PressCommander Board Stack)

Part #35-111 Ethernet option for the PressCommander Standard Display

PressCommander Options - Resolver Based

Micro-Inching Function (includes key switch on/off)

Light Guard on/off supervisory controlled key switch (up to four curtains)

Multiple operator station control key switch

Bar Turnover Function (includes key switch on/off)

Die Block receptacle outlet

Shutdown timer (software based)

110VAC outlet or 220 VAC outlet (specify load)

NEMA style indicators & switchgear on control panel to replace IEC style supplied standard

SHUT HEIGHT INDICATOR:

Provides the capability to read the shut height to within .001 inch and will display the position of the slide. Each tool/die setting is saved under the job number. Shut Height Monitoring requires a shut height interface board (Part# 52-298) and a linear sensor for slide position measurement.

Choose a length below: A magnet and two mounting brackets are supplied standard with all linear sensors.

Size

4" - Part# 40-009

8" - Part# 40-010

12" - Part# 40-011

16" - Part# 40-012

24" - Part# 40-013

AUTOMATIC EXTERNAL TRIP:

PCS-10 without IEC switchgear (at time of purchase)

PCS-20 with IEC switchgear (key switches & push buttons)

30-012 24vdc @ 2.2A power supply (90-260vac In) 3.9" L x 3.8" W x 1.4" H (99.1mm x 96.5mm x 35.6mm)
for powering sensors or other auxiliary devices

CONTINUOUS ON DEMAND:

PCS-10 without IEC switchgear (at time of purchase)

PCS-20 with IEC switchgear (key switches & push buttons)

Custom Software Programming (one time fee).

REMOTE MONITORING: (internet based)

Ethernet 100baseT with built in Web page Server (with downtime monitor and logging)

Wireless Ethernet (Wi-Fi) Bridge - Part # 39-154

GUARDING:

Safety Light Curtain (up to four sets of pylons, specify size) (Visit www.pinnaclesystems.com for models available)

HYDRAULIC OVERLOAD:

Press will stop when output opens, then allows the press to be moved in the inch mode with the input still open.

CUSTOMIZED SOFTWARE PROGRAMMING:

Software can be upgraded in the field with a laptop computer.

Options continued on next page.

PressCommander Options - Resolver Based

CLUTCH-BRAKE TIME DELAY HUB OPTION:

Provides the press control with a separate relay for the CLUTCH and a separate relay for the BRAKE to allow for a time delay between each, and to be control reliable.

Consists of the following:

- 1 - Safety HUB (Part# 53-448) running the Clutch-Brake program
- 1 - 24VDC Power Supply (Part# 30-012)
- 2 - Safety Relays for HUB channel D (Part # 52-278)

PEAK TONNAGE MONITORING: (add suffix T1,T2,T3,or T4 to Presscommander Model#)

T1 - One channel monitoring with strain sensor and cable

T2 - Two channel monitoring with strain sensor and cable

T3 - Three channel monitoring with strain sensor and cable

T4 - Four channel monitoring with strain sensor and cable

SIGNATURE TONNAGE ANALYSIS MONITORING (Requires 10.1" Touchscreen - Part # 39-151)

Add suffix: T1-S, T2-S, T3-S, T4-S to the PressCommander Model.

T1-S - One channel monitoring with strain sensor and cable

T2-S - Two channel monitoring with strain sensor and cable

T3-S - Three channel monitoring with strain sensor and cable

T4-S - Four channel monitoring with strain sensor and cable

Part# 39-151

10.1" color touchscreen replaces the Standard PressCommander four line vacuum fluorescent display mounted onto NEMA 12 (IP 64) control panel. Includes Production Monitoring to create OEE.

Remote Master Control Station with 10.1" color touchscreen

Moves all the switchgear and the touchscreen until into a separate 12" x 14" x 8" box that can be placed closer to the operator. The control boards, optional starter(s), optional disconnect remain in a separate control panel whose size is dictated by the size of the starter(s) and disconnect. This requires the Ethernet option to be installed on the Touchscreen.

Part# 43-027 (Required)

Ethernet cable to connect the Remote Master Control 10.1" color touchscreen to the control panel that contains the control boards, optional starters and disconnects. Specify length needed in feet.

Optional: PressCommander Touchscreen

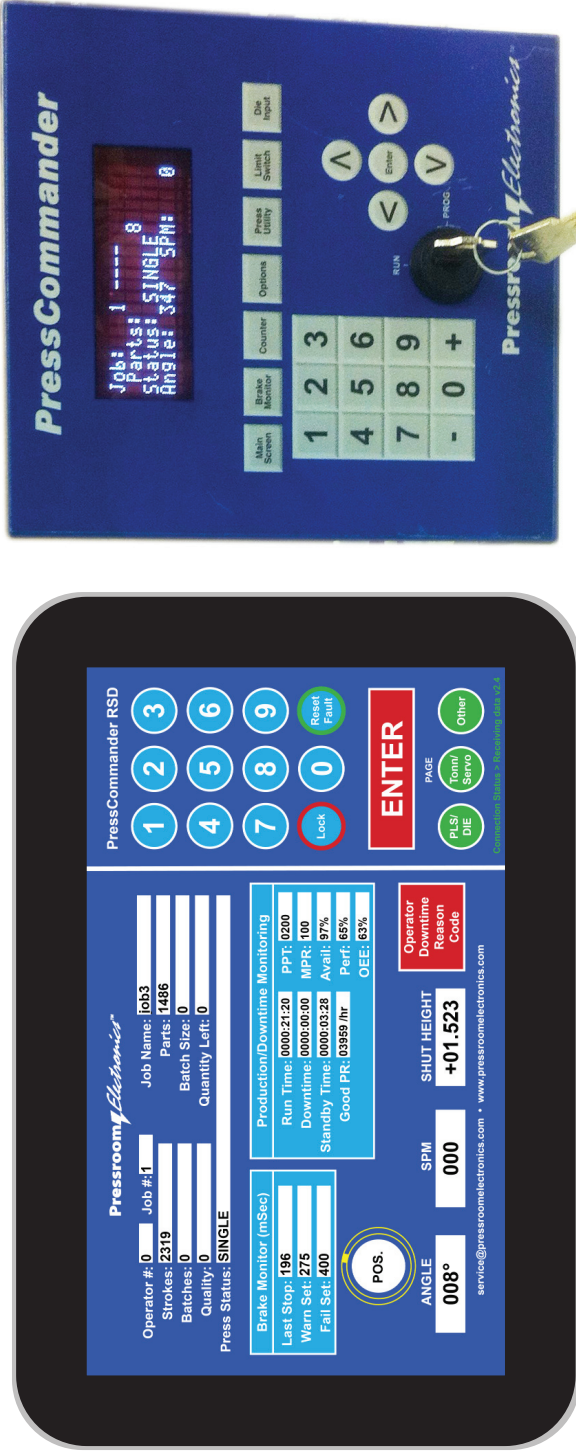

The 10.1" color touchscreen (Part #39-151) option replaces the standard PressCommander alpha-numeric four line by twenty character display (shown above right) of the resolver based PressCommander Press Control.

The color touchscreen provides full programming capability for the PressCommander operational features such as timers, counters, die protection, tonnage monitoring (peak or signature), PLS (programmable limit switches) and Downtime Production Monitoring. Standard features and function listing can be found on page A2 of this catalog. The color touchscreen features also incorporate a Windows Operating Systems and 32 GB of memory.

The optional PressCommander Touchscreen provides simple connectivity with the built-in wireless Windows operating system. This will provide the operator and front line supervisor with the press operational status information. This can also provide automatic population of press data into Excel spreadsheet formats if desired via log files for the machine's production status and Downtime reasons.

The following pages will illustrate the functional layout of the various pre-programmed (yet customizable) screens. This will provide the user with a simple format for accessing the various built-in features for enhancing machine utilization and ease of operation from the production machine.

Actual Size of PressCommander Touchscreen

Operator Screen

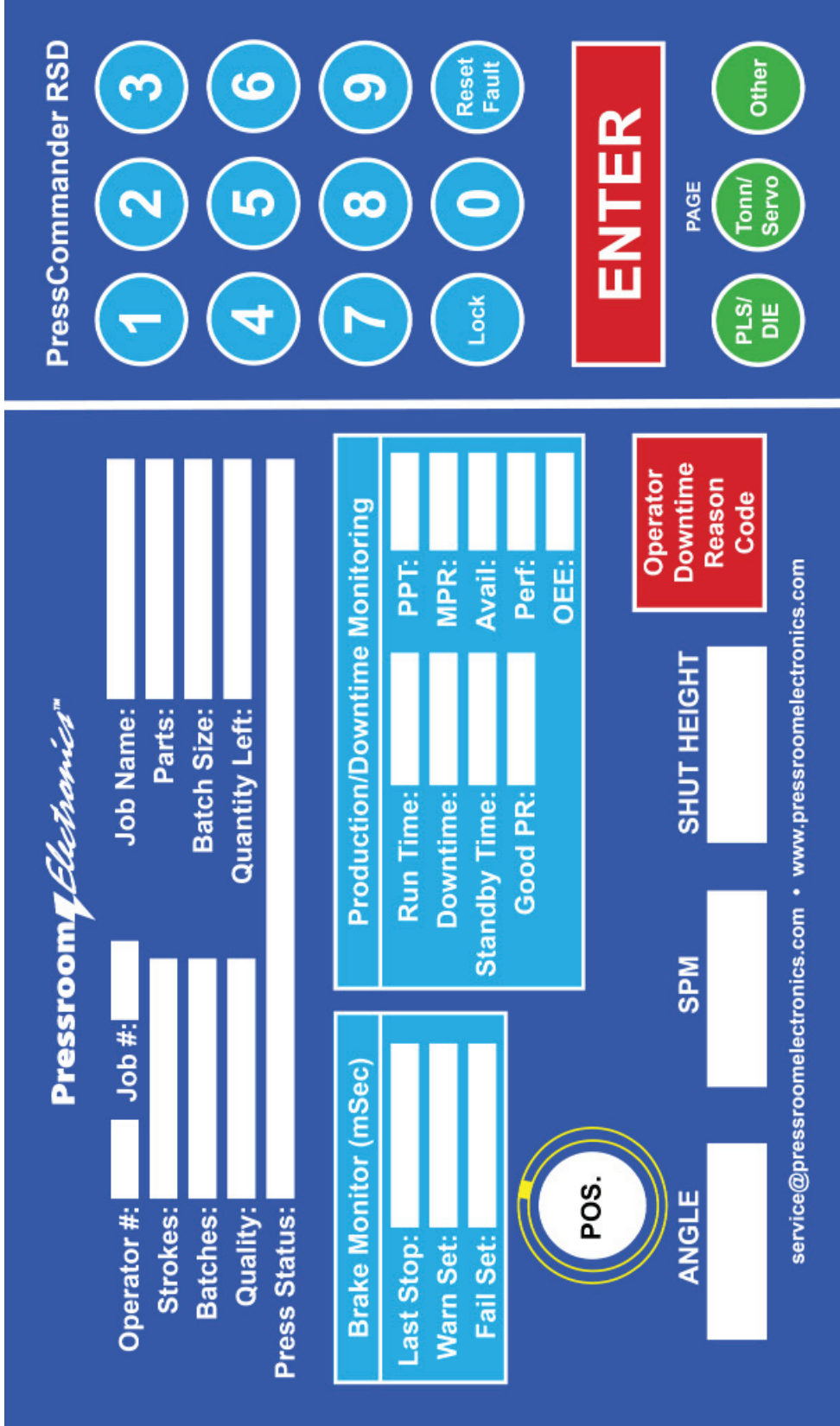

The Operator Screen displays the pertinent press information for the job that is running on the press. Also shown is the Production/Downtime section, which updates automatically in real time the production and downtime status of the press. This management tool is calculated automatically and produces the OEE (Overall Equipment Effectiveness) of the press. Excellent information for the press operator and front line supervisor which is calculated on the production floor "at the machine" and easily transmitted to the production office where the information is stored and data is shared globally by all team members, if desired by the management team.

PRODUCTION/DOWNTIME MONITORING DEFINITIONS:

Run Time	Actual time spent making parts.
Downtime	Actual time spent on Operator Downtime (i.e. Reason Code) or Press Fault Code (i.e. Brake Fault, Die Fault).
Standby Time	Idle Time (i.e. breaks, lunch) or Operator did not specify Reason Code.
Good PR	Actual Part Rate (defined as Parts/Hour that are good).
PPT	(user entry) Planned Production Time - This is the standard maximum amount of time (in minutes) the machine should operate each Shift (subtracting breaks, lunch, etc.)
MPR	(user entry) Maximum Production Rate - This is the Maximum Part Rate (in Parts per Minute) that you would expect based on normal operation (this takes into account aging equipment, tools and substandard material).
Avail	(Availability %) - Actual Operating time / SPT (defined as what percentage of available time does the Press make parts).
Perf	(Performance %) - Actual Parts / Actual Operating time / MPR (defined as what percentage of parts did you make compared to the Maximum parts you could make).
OEE	Overall Equipment Effectiveness = Availability x Performance x Quality

Note: All of these values also appear in the log file as well. You can also change the DRIVE location of the LOG files (i.e. Remote Hard Drive Server) which provides access to the LOG files even when the Press is OFF.

TOUCHSCREEN DOWNTIME & PRODUCTION MONITORING FOR OVERALL EQUIPMENT EFFECTIVENESS (OEE).

Requires Touchscreen Part# 39-151

20 Downtime Codes - Downtime codes are user programmable and customized to need. Downtime codes can be activated either by manually touching the appropriate touchscreen button **OR** Automatically via the machine circuit signal that caused the machine to stop. This capability provides an exceptional granular fault cause for machine operational analysis.

If machine induced automatic signalling is desired to activate a specific downtime code (such as die protection, tonnage monitoring, shortfeed, misfeed etc.) One of the following input/output interface boards are required.

Part# 52-320	Provides the capability for six (6) downtime codes to be activated automatically by existing machine control electrics.
Part# 52-321	Provides the capability for sixteen (16) downtime codes to be activated automatically by existing machine control electrics.
Part# 52-320 and 52-321	Also include six (6) dry contact relays that can be used to signal stack lights, alarms etc. Relay Ratings: 5A @ 250 VAC • 5A @ 30 VDC • Coil: 12 VDC

Operator Screen

Pressroom Electronics™

Operator #: **0** Job #: **1** Job Name: **job3**
 Strokes: **2319** Parts: **1486**
 Batches: **0** Batch Size: **0**
 Quality: **0** Quantity Left: **0**
 Press Status: **SINGLE**

Brake Monitor (mSec)
 Last Stop: **196**
 Warn Set: **275**
 Fail Set: **400**

Production/Downtime Monitoring
 Run Time: **0000:21:20** PPT: **0200**
 Downtime: **0000:00:00** MPR: **100**
 Standby Time: **0000:03:28** Avail: **97%**
 Good PR: **03959 /hr** Perf: **65%**
 OEE: **63%**

ANGLE **008°** SPM **000** SHUT HEIGHT **+01.523**

Operator Downtime Reason Code

service@pressroomelectronics.com • www.pressroomelectronics.com

PressCommander RSD

1 2 3 4 5 6 7 8 9 Lock 0 Reset Fault

ENTER

PAGE PLS/DIE Tonn/Servo Other

Connection Status > Receiving data v2.4

Real Time Press data (Production/Downtime Monitoring) including Parts & Batch Count, Crank Angle, along with Downtime Monitoring recorded into Excel Spreadsheet files automatically.

Die Protection/PLS Screen

359° *Pressroom Electronics™* **000 SPM**

PressCommander RSD

NAME	Spd	CLS-OPN	CLS-OPN	DLY-HLD	CLS-TIM	PLS
1 LUBE		100-200	000-000	000-000	000-000	
2 CHUTE		100-200	000-000	000-000	000-000	
3 PILOT		170-190	000-000	000-000	000-000	
4 LS4		000-000	000-000	000-000	000-000	
5 LS5		000-000	000-000	000-000	000-000	
6 LS6		000-000	000-000	000-000	000-000	

NAME	TYPE	STP	BGN-END	WND	FLT	DIE
1 EJECT1	MOM	E	000-000			
2 EJECT2	MOM	E	000-000			
3 PNP	MOM	E	000-000			
4 EOS	MOM	E	000-000			
5 SEN5	MOM	E	000-000			
6 SEN6	MOM	E	000-000			

KEY

PLS * = RLY ON

Spd * = Speed Comp ON

CLS-OPN = In DEG.

DLY-HLD = Cycles

TIM = Time in 100thSec

7-12

0
Lock

0
Reset Fault

ENTER

Main

Tonn/
Servo

Other

Connection Status > Receiving data v2.4

service@pressroomelectronics.com • www.pressroomelectronics.com

6 Programmable Outputs (PLS) and 6 Programmable Inputs (Die Protection) supplied standard.

Optional: Expander Board #52-279 adds additional 6 Die inputs and 6 Dry relay contact outputs (At time of order) - Increases the PressCommander die protection from six (6) to twelve (12) station die protection. Also increases the PressCommander programmable limit switch capacity from six (6) to twelve (12) programmable limit switches with mechanical relay (dry) outputs.

Expander power supply board #52-280 (At time of order) - Power Supply Board that stacks under the PressCommander Expander Board (52-279) and is required to power the Expander Board functions.

Request Both Part Numbers (52-279 and 52-280) at time of order if expansion is desired.

Servo Control/Tonnage Monitoring Screen

359° **Pressroom** *Electronics™* **000 SPM**

Machine Tonn: **200**

Tonnage Monitor

	Last	High	Low	Min	Max
Left Rear:	023	000	000	001	050
Right Rear:	013	000	000	001	050
Left Front:	000	000	000	000	000
Right Front:	000	000	000	000	000

Servo: Indramat

Speed: 090%

Accel: 085%

Length: 50.125"

Option: 0°

Tonnage Record **START**

PressCommander RSD

1

2

3

4

5

6

7

8

9

0

Lock

Reset Fault

ENTER

PAGE

Main

PLS/DIE

Other

Connection Status > Receiving data v2.4

service@pressroomelectronics.com • www.pressroomelectronics.com

Displayed is the Servo Control. Optional 2 or 4 channel Peak Tonnage Monitoring or Signature Analysis shown above. All data can be recorded into log files.

Press Set-up Screen

359°

Pressroom *Electronics™*

000 SPM

Press Commander RSD

Press Control (deg)

Min Speed: 000	pmlink: <input type="checkbox"/>	Stop: 285°	000°
Max Speed: 150	Job Rst: <input type="checkbox"/>	By-Pass: 180°	
Motion Det: 0.3		Limit: 020°	
Spd Comp: 0°	Spd On: <input type="checkbox"/>	Die-Tstp: 000°	

OPTO INPUTS

01100000	10000110	11101000	00000010
-----------------	-----------------	-----------------	-----------------

service@pressroomelectronics.com • www.pressroomelectronics.com

Lock

Reset Fault

ENTER

PAGE

Main

PLS/ DIE

Tonn/ Servo

Connection Status > Receiving data v2.4

Press setup parameters

Fault Message Screen

359° Pressroom Electronics™ 000 SPM

FAULTS:

DRIFT FAULT (Press detected in motion, but not activated)
RESOLVER FAULT 2 (Cable problem or Analog circuit failure)
RESOLVER FAULT 3 (Cable problem or Analog circuit failure)
M/S ANGLE MISMATCH (Master and Slave press angles don't match)

(Sample of fault messages.)

service@pressroomelectronics.com • www.pressroomelectronics.com

PressCommander RSD

1 2 3
 4 5 6
 7 8 9
 Lock 0 Reset Fault

ENTER

PAGE
 Main Tonn/Servo Other

Connection Status > Receiving data v2.4

PLS/DIE

Fault monitoring messages can be recorded into Excel spreadsheet files automatically.

Downtime and Production Monitoring Screen

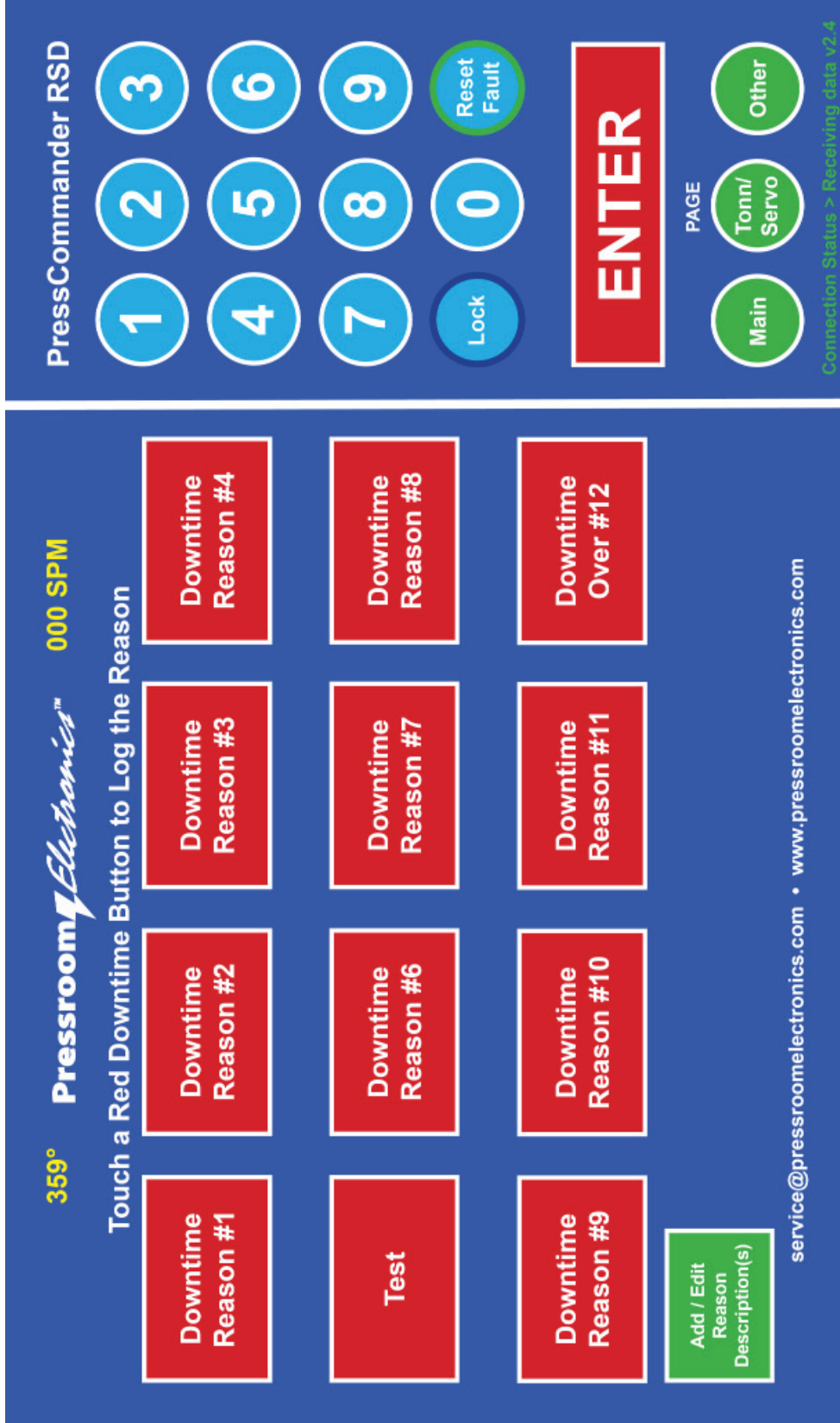

The operator can manually select a Reason which is automatically entered into the LOG file. The Reason is declared over when the Press RUNS or the Downtime Over button is selected (and is logged).

Downtime and Production Monitoring Screen

359° Pressroom Electronics™ 000 SPM

Touch a line to Add / Edit Downtime Button Reason

- 1 Downtime Reason #1
- 2 Downtime Reason #2
- 3 Downtime Reason #3
- 4 Downtime Reason #4
- 5 Test
- 6 Downtime Reason #6
- 7 Downtime Reason #7
- 8 Downtime Reason #8
- 9 Downtime Reason #9
- 10 Downtime Reason #10
- 11 Downtime Reason #11
- 12 Downtime Over #12

service@pressroomelectronics.com • www.pressroomelectronics.com

PressCommander RSD

1 2 3
4 5 6
7 8 9
Lock 0 Reset Fault

ENTER

PAGE
Main Tonni/Servo Other

Connection Status > Receiving data v2.4

During operation the user can add and edit 24 Reason Codes (up to 30 characters in length). The reasons are stored on the users computer in a log file. System is capable of manual or automatic machine input of downtime reason(s). Downtime codes can be recorded automatically into Excel spreadsheets, Pareto charts or Pivot tables.

Production / Downtime Monitoring Features, Benefits & Implementation

The Pressroom Electronics Production & Downtime Monitoring System (PDMS) represents an invaluable shop floor control and management tool. Through diligent use of the system, the management team can achieve significant gains to the overall operating performance of the plant. Indices related to Productivity, Throughput, Rework, Order Fulfillment, and Quality are common areas of impact.

Typically, there are four (4) phases to the implementation of the system:

- **Understanding the Mechanics:** As with anything new, the users will go through a short period of time to understand the inputs to and the resultant outputs from the system.
- **Interpretation of the Data:** The supervisors and management team acquire a unified understanding of the data and the indices of performance from the reporting elements of the system.
- **Use of the Data:** The supervisors and management team begin to use the data to manage the day to day operations and to improve the performance of the plant.
- **Continuous Improvement (CI):** The system is used as a key component to establish budgets, long term plans relative to capacity constraints and for CI projects.

Production / Downtime Monitoring Features, Benefits & Implementation Cont.

As a value added service, Pressroom Electronics offers on-site consultants who provide assistance in augmenting and accelerating the rate of implementation of the Production & Downtime Monitoring System. Among the services offered:

- **Shop Floor Coaching:** Time spent directly with the Supervisor/ Manager coaching them on the mechanics and use of the System as well as the indices of performance. This process accelerates the individual(s) understanding of the system and ensures a unified understanding of the data and indices of performance among the management team.
- **Engineered Standards:** This involves the establishment of Engineered Standards which are a key component to the integrity and effective use of the data and indices derived from the system.
- **Facilitate Daily Review Meetings (DRM):** Establish the timing, attendance and agenda for this important daily review meeting. Involves the facilitation of the meetings based on the data and downtime reported from the system and the training of the chairperson for perpetuity. This enables the ongoing and effective execution of these important daily corrective action meetings.
- **Performance Measurement Reporting:** Involves the custom design of the Daily Operating Report and the Weekly Management Report, including performance trend graphs. Targets the Key Performance Indicators (KPI) and other pertinent data that can be derived from the system. This enables timely, accurate and meaningful performance reporting.

Touchscreen Cutout Pattern

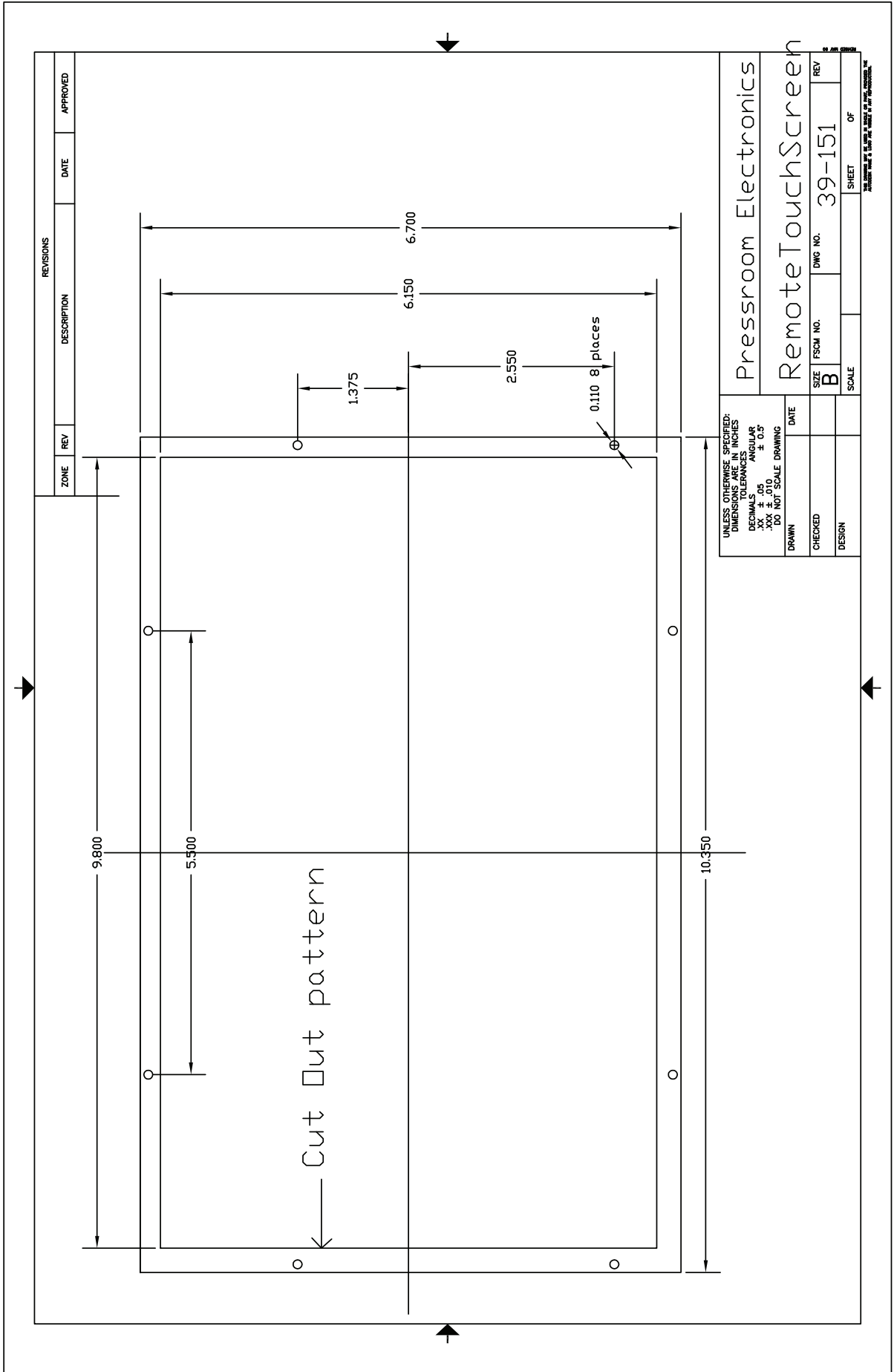

Punch Press Controls Overview

Resolver Based "PressCommander" Punch Press Control

For press speed range 1-500 Strokes Per Minute (SPM)



Exceeds OSHA 1910.217 & ANSI B11.1-2009, "Control Reliable Design," with dual logic power supplies, heavy duty resolver, System diagnostics and programming in plain English/Spanish which can control up to four sets of operator stations, Major faults such as E-Stop, motion, brake monitor, and sensor faults are handled by two force-guided relays (Form B safety relays), Off--inch--single--continuous, Continuous ARM; top stop, anti-tie down and anti-repeat, SPM Range (1 to 500), Password and supervisory controlled keyed selector switch for security of data entry, Interrupted stroke provision with indicator, Inch mode monitoring, Crank angle and speed readout (SPM), Time-based brake monitor, Built-in motion detector and drift fault, 90° and 270° stop time tester/meter built-in, Built-in hour meter for maintenance, Built-in variable speed compensation, Servo-feed interface built-in, Six optically isolated die protection inputs, Six PLS (programmable limit switch) output relays, 100 job memory, Stroke, batch, quality, and part counters, Batch counter output relay, Die protection output relay, Speed output relay and Auxiliary output relay.

Optional: Ethernet or DeviceNet and PC Link to allow offline job creation and storage.

Optional: 10.1" color touchscreen replaces the standard display shown. (Includes Production Monitoring to create OEE.)

Optional: Expander Board (52-279) - Increases the die protection to 12 stations and the programmable limit switches (PLS) to twelve.

Part Number	Description (Resolver and resolver cable are included with all models).
PCS-05	PressCommander (Boards Only) Clutch/Brake System with remote standard display
PCS-08	PressCommander (Boards Only) Clutch/Brake System with remote standard display, IEC switches, push buttons and legend plates
PCS-10	PressCommander mounted on panel backplate with remote standard display
PCS-20	PressCommander mounted on panel backplate with remote standard display, IEC switches, push buttons and legend plates
PCS-2000	PressCommander NEMA12 (IP64) control panel with IEC Components
PCS-2000-SFP	<p>PressCommander Small Form Package</p> <p>The Small Form Package comes in a 12" x 14" x 8" NEMA 12 Control box and is the same price as a base PCS-2000 unit. It is based on a standard PCS-2000 which comes in a 20" x 20" x 8" box (going up in size depending on options). The SFP does not come with the step-down transformer and is not for customers who require additional options (i.e. Starter(s) , Disconnect, etc.). The SFP is for customers who already have a Panel for high voltage/high current equipment, and want the Controls to be closer to the operator.</p> <p>NOTE: There is no cable length limitation between the SFP and the high voltage equipment.</p>
PCS-4000	<p>PressCommander NEMA12 (IP64) control panel & IEC components</p> <p>Model #PCS-4000 control panel includes the following components:</p> <ul style="list-style-type: none"> No. 303A Dual Solenoid Valve with Muffler No. 306 Heavy duty pressure switch 52-227 Heavy duty brushless Resolver transducer (formerly 40-003) No. 311 Filter, regulator, lubricator No. UL-501 operator station

***Optional:** 10.1" color touchscreen replaces the standard display and is available for all models listed above.

Note -- IEC switchgear supplied standard (NEMA optional). Adder to replace standard IEC switchgear with NEMA switchgear.

Punch Press Controls Overview

Resolver Based “PressCommander” Punch Press Control “High Speed” For press speed range above 500 Strokes Per Minute (SPM)



Exceeds OSHA 1910.217 & ANSI B11.1-2009, “Control Reliable Design,” with dual logic power supplies, heavy duty resolver, System diagnostics and programming in plain English/Spanish which can control up to four sets of operator stations, Major faults such as E-Stop, motion, brake monitor, and sensor faults are handled by two force-guided relays (Form B safety relays), Off--inch--single--continuous, Continuous ARM; top stop, anti-tie down and anti-repeat, SPM Range (500 and above), Password and supervisory controlled keyed selector switch for security of data entry, Interrupted stroke provision with indicator, Inch mode monitoring, Crank angle and speed readout (SPM), Time-based brake monitor, Built-in motion detector and drift fault, 90° and 270° stop time tester/meter built-in, Built-in hour meter for maintenance, Built-in variable speed compensation, Servo-feed interface built-in, Six optically isolated die protection inputs, Six PLS (programmable limit switch) output relays, 100 job memory, Stroke, batch, quality, and part counters, Batch counter output relay, Die protection output relay, Speed output relay and Auxiliary output relay.

Optional: Ethernet or DeviceNet and PC Link to allow offline job creation and storage.

Optional: 10.1” color touchscreen replaces the standard display shown. (Includes Production Monitoring to create OEE.)

Optional: Expander Board (52-279) - Increases the die protection to 12 stations and the programmable limit switches (PLS) to twelve.

Part Number	Description (Resolver and resolver cable are included with all models).
PCS-05-OPTO	High Speed PressCommander (Boards Only) Clutch/Brake System with remote standard display
PCS-08-OPTO	High Speed PressCommander (Boards Only) Clutch/Brake System with remote status standard display, IEC switches, push buttons and legend plates
PCS-10-OPTO	High Speed PressCommander mounted on panel backplate with remote standard display
PCS-20-OPTO	High Speed PressCommander mounted on panel backplate with remote standard display, IEC switches and push buttons
PCS-2000-OPTO	High Speed PressCommander NEMA12 (IP64) control panel with IEC Components
PCS-4000-OPTO	High Speed PressCommander NEMA12 (IP64) control panel & IEC components

Model #PCS-4000-OPTO control panel includes the following components:

- No. 303A Dual Solenoid Valve with Muffler
- No. 306 Heavy duty pressure switch
- 52-227 Heavy duty brushless Resolver transducer (formerly 40-003)
- No. 311 Filter, regulator, lubricator
- No. UL-501 operator station

Important Ordering Information for the PCS OPTO: The Programmable relay outputs (PLS1- 6) are normally a mechanical (dry contact) relay with 5A contacts. The PCS-OPTO replaces the PLS1-6 with Solid-State relays. The customer has the choice of replaceable Solid-State outputs PN# 37-045 3.0A @ 24VDC only, OR PN# 37-047 0.5A @ 120VAC/DC. The customer must specify which type of output at the time of order. (no difference in cost)

***Optional:** 10.1” color touchscreen replaces the standard display and is available for all models listed above.

Note -- IEC switchgear supplied standard (NEMA optional). Adder to replace standard IEC switchgear with NEMA switchgear.

Various Models of PressCommander

Resolver Based Punch Press Controls

PCS-05*



Shown with Panel Mount Message Display

The Board Only Commander Module

The redundant clutch/brake punch press control module with a remote panel mount message display (available in English or Spanish).



Resolver Transducer

Shown with 30' connector cabling supplied standard

Touchscreen is optional for all models.

Model PCS-05 includes:

- Master Board
- Slave Board
- Power Supply Board
- Diagnostic Message Display
- Connecting Cables
- Cover/Hardware
- Software (Master) microprocessor
- Software (Slave) microprocessor

PCS-08*



The redundant clutch/brake punch press control module with a remote panel mount message display (available in English or Spanish). Also included are all of the switches, legend plates, push buttons, and indicator lights for easy mounting into your existing control.



Resolver Transducer

Shown with 30' connector cabling supplied standard

Model PCS-08 includes:

- Master Board
- Slave Board
- Power Supply Board
- Diagnostic Message Display
- Connecting Cables
- Cover/Hardware
- Software (Master) microprocessor
- Software (Slave) microprocessor

Push buttons & legend plates for:

- System start
- System stop
- Automatic continuous set-up

Indicators & legend plates for:

- System on
- Ground fault
- Brake monitor
- Interrupted stroke provision

PCS-10*



Shown with Panel Mount Message Display

The compact Model PCS-10 is big in safety and automation control. The redundant clutch/brake punch press control module has a remote panel mount message display (available in English or Spanish).



Resolver Transducer

Shown with 30' connector cabling supplied standard

Model PCS-10 includes:

- Control reliable design (triple CPU redundancy)
- Diagnostic Message Display
- Fused transformer
- Control Module pre-wired to terminal strip
- Pressure clamp terminal strip
- Mounted on an 18" (457mm) x 18" (457mm) backplate
- Wiring diagram and complete installation instructions supplied
- Modes of operation off - inch - single - continuous
- Continuous ARM
- Top stop
- Anti-tie down and anti-repeat
- System start/stop functions
- SPM Range - 1 to 500
- Interrupted stroke provision with indicator

- Inch mode monitoring
- Control module provides anti-tie down and concurrency function for up to four sets of operator stations
- Light curtain mute-out on upstroke standard
- Clutch/brake module designed to fit into tight spaces.
- Printed circuit board dimensions; only 6.5" (165mm) x 5" (127mm) x 4" (102mm) including standoff.
- Control systems are captively designed, manufactured and supported.
- Self-contained plain English message display
- Self-diagnostic system
- The control module monitors the signals and circuits as specified by OSHA and ANSI standards.
- Control incorporates dual logic power supplies
- Two-year warranty on control modules and resolver

Various Models of PressCommander

Resolver Based Punch Press Controls

PCS-20*



Model PCS-20 encompasses all of the features and components of Model PCS-10 plus all of the switches, legend plates, push buttons, and indicator lights for easy mounting into your existing control.

Model PCS-20 includes:
Keyed selector switches and legend plates for:

- Hand/foot mode
- Off/inch/single/continuous

Push buttons and legend plates for:

- System start
- System stop
- Automatic continuous set-up

Indicators and legend plates for:

- System on
- Ground fault
- Brake monitor
- Interrupted stroke provision



Resolver Transducer

Shown with 30' connector cabling supplied standard

Touchscreen is optional for all models.

PCS-2000*



The Model PCS-2000 Control System is completely prewired and ready for installation. System supplied complete with a well marked terminal strip for easy, safe, and accurate electrical interface to the various punch press components. Due to the hybrid design characteristics, a main power disconnect switch and magnetic motor starter can be supplied in the same control panel.

Customer to specify operator control location (photo on the left displays operator controls on panel door).

Our ordering/proposal form will allow you to configure your system exactly how you want it.



Resolver Transducer

Shown with 30' connector cabling supplied standard

Model PCS-2000 includes:

- NEMA 12 Enclosure
- System Start Guarded Push Button (Air and Power Interlock)
- System Stop Unguarded Push Button
- System On Indicator Light
- Plain English messages for status and system self-diagnostics
- Automatic Continuous Set Up Push Button - This prior action push button must be operated to set-up the press for continuous operation. Once depressed, the operator has a preset length of time in which to depress both palm buttons concurrently to initiate operation in the continuous mode.
- Time-Based Brake Monitor
- Ground Fault Detector - Oil tight push to test type wired to continuously monitor press grounding whenever control power is on.

- Continuous Arm Timer
- Fused Secondary Pressure Clamp Terminals
- Hand/Foot Mode Two position keyed selector for hand or foot mode initiation.
- Transformer To reduce voltage from 480/240VAC to 120VAC secondary. Consult factory for 208 or 550 volt system.
- Interrupted stroke provision
- Keyed Mode Selector Off-Inch-Single- Continuous Four position keyed lock selector switch for supervised selection of mode of operation of the press. When in the inch mode, the operator cannot hold or tie one run button down and use the other button to inch the press with one hand operation. Both buttons must be depressed concurrently. Microinching and Automatic External Trip optional.

PCS-4000 Resolver Based Punch Press Control & Components

Touchscreen is optional.

PCS-4000*



Incorporates all the requirements of OSHA for control reliability and component monitoring. Also includes component and system diagnostics with indicator lights for total press monitoring. Complies with section 1910.217 of the Federal Register and ANSI Standard B11.1-2009.

When foot actuation is used, a method of guarding the point of operation must be provided.

Refer to the PressCommander Options in this catalog for a complete listing of the PCS-4000 features.

***** Includes the same features as the PressCommander listed on page A9. Each model varies slightly in it's packaging. See individual product descriptions for details.

PCS-4000 includes the following:



Dual Solenoid Valve

The dual solenoid valve is monitored and contains a pressure controlled spool in an assembly mounted between the pilot and valve body assemblies. Pressure signals are applied to each end of the monitor spool. If these signals differ by more than a built-in design limit, they cause the spool to shift to a latched position. The spool movement causes the pilots to be exhausted and pilot supply air to be vented to the atmosphere, thus rendering the valve inoperable. The monitor must be reset by unlatching the spool before another valve cycle can be initiated.



Operator Station

No. UL-501 Two UltraTouch modules mounted on a NEMA 12 operator station run bar with a red mushroom emergency stop button located in the center and a yellow mushroom top stop button located off center. This style assembly is ideal for the metal stamping/metal fabrication industry. All the modules are mounted in accordance to OSHA, ANSI, and CSA standards in regards to run button spacing.



Heavy Duty Pressure switch No. 306

This NEMA 12 oil-tight and dust-tight switch is adjustable from 1 to 115 PSI.



Filter Regulator Lubricator No. 311



Industrial Grade Brushless Resolver Transducer Part No. 40-003

Heavy duty brushless resolver transducer which replaces the current mechanical rotary cam switch. Resolver Cabling 30' Part No. 45-020

PressCommander Proposal/Ordering Guide

Resolver Based Controls (All Models/Styles)

Please complete the form on the next two pages and email it to the Pressroom Sales Department at sales@pressroomelectronics.com. You may also fax the form to (412) 262-1197. We also have an electronic version of this form available on our website www.pressroomelectronics.com.

Name _____	Email _____
Company _____	Punch Press Manufacturer _____
Address _____	Model # _____ Serial # _____
City _____	Shop # _____ Press Speed (SPM) _____
State _____ Zip _____	Voltage _____ Cycle _____ Phase _____
Phone _____	Fax _____

*All PressCommander Models include clutch/brake and integrated automation control capability, standard display, resolver and 30' (9.1m) of connector ended resolver cable.

PCS-05



*Components as stated above.

PCS-08



*Components plus switches, legend plates, indicators and push buttons.

PCS-10



*Components mounted on a blackplate. Prewired to terminal strip.

PCS-20



*Components mounted on a backplate and prewired to terminal strip. Includes all switches, legend plates, indicators and push buttons.

PCS-2000



*Components housed in a NEMA 12 (IP64) steel control panel. Prewired to terminal strip.

Optional Touchscreen Display

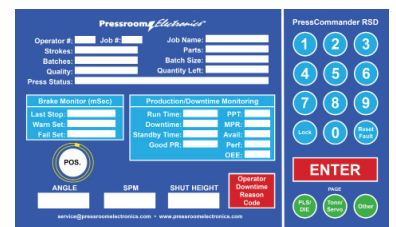

Replaces standard display in all PCS Models. Part #39-151.

PressCommander Proposal/Ordering Guide

Resolver Based Controls with Standard Display (All Models/Styles)

1 to 500 SPM Press Speed

Qty. PCS-05

PCS-08

PCS-10

PCS-20

PCS-2000

Specify Operator Control Location on Control Panel:
 Left End Panel Door Right End

Above 500 SPM Press Speed

Qty. PCS-05-OPTO

PCS-08-OPTO

PCS-10-OPTO

PCS-20-OPTO

PCS-2000-OPTO

Specify Operator Control Location on Control Panel:
 Left End Panel Door Right End

PCS-2000-SFP PressCommander Small Form Package
 The PCS-2000-SFP comes in a 12" x 14" x 8" NEMA 12 Control box and is the same price as a base PCS-2000 unit. It is based on a standard PCS-2000 which comes in a 20" x 20" x 8" box (going up in size depending on options). The SFP does not come with the step-down transformer and is not for customers who require additional options (i.e. Starter(s) , Disconnect, etc.). The SFP is for customers who already have a Panel for high voltage/high current equipment, and want the Controls to be closer to the operator.
 NOTE: There is no cable length limitation between the SFP and the high voltage equipment control panel.

PCS-4000 (1 to 500 SPM Press Speed) or **PCS-4000-OPTO (Above 500 SPM Press Speed)**

Specify Operator Control Location (for either model):
 Left End Panel Door Right End

Fused Main Power Disconnect - Refer to Main Power Disconnect Section
 Mounted on control panel _____ AMP
 Choose Style: IEC NEMA Part# _____

Main Motor Magnetic Motor Starter - Refer to Main Power Disconnect Section
 Choose Style: IEC NEMA
 Choose: Rev Non-Rev
 _____ HP _____ Full Load Amps Part# _____
 Includes on/off push buttons and keyed selector switch forward/reverse when applicable.

Ram Adjust Magnetic Motor Starter - Refer to Main Power Disconnect Section
 Choose Style: IEC NEMA
 _____ HP _____ Full Load Amps Part# _____
 Includes up/down push buttons and keyed selector switch forward/reverse when applicable.

Accessory Magnetic Motor Starter - Refer to Main Power Disconnect Section
 Choose Style: IEC NEMA
 Choose: Rev Non-Rev
 _____ HP _____ Full Load Amps Part# _____
 Includes on/off push buttons and keyed selector switch forward/reverse when applicable.

PressCommander Proposal/Ordering Guide

Resolver Based Controls with Standard Display (All Models/Styles)

- | | |
|------------------------------------------------------------------------------------------------------------------------------------------------------------------------------------------------------------------------------------------------------------------------------------------------------------------------------------------------------------------------------------------------------------------------------------------------------------------------------------------------------------------------------------------------------------------------------------------------------------------------------------------------------------------------------------------------------------------------------------------------------------------------------------------------------------------------------------------------------------------------------------------------------------------------------------------------------------------------------------------------------------------------------------------------------------------------------------------------------------------------------------------------------------------------------------------------------------------------------------------------------------------------------------------------------------------------------------------------------------------------------------------------------------------------------------------------------------------------------------------------------------------------------------------------------------------------------------------------------------------------------------------------------------------------------------------------------------------------------------------------------------------------------------------------------------------------------------------------------------------------------------------------------------------------------------------------------------|-----------------------------------------------------------------------------------------------------------------------------------------------------------------------------------------------------------------------------------------------------------------------------------------------------------------------------------------------------------------------------------------------------------------------------------------------------------------------------------------------------------------------------------------------------------------------------------------------------------------------------------------------------------------------------------------------------------------------------------------------------------------------------------------------------------------------------------------------------------------------------------------------------------------------------------------------------------------------------------------------------------------------------------------------------------------------------------------------------------------------------------------------------------------------------------------------------------------------------------------------------------------------------------------------------------------------------------------------------------------------------------------------------------------------------------------------------------------------------------------------------------------------------------------------------------------------------------------------------------------------------------------------------------------------------------------------------------------------------------------------------------------------------------------------------------------------------------------------------------------------------------------------------------------------------------------------------------------------------------------------------------------------------------------------------------------------------------------------------------------------------------------------------------------------------------------------------------------------------------------------------------------------------------------------------------------------------------------------------------------------------------------------------------------------------------------------------------------------------------------------------------------------------------------------------------------------------------------------------------------------------------------------------------------------------------------------------------------------------------------------------------------------------------------------------|
| <p>Qty. <input type="checkbox"/> Micro-Inching Feature</p> <p><input type="checkbox"/> Automatic External Trip</p> <p><input type="checkbox"/> Continuous On Demand</p> <p><input type="checkbox"/> Light Curtain On/Off Key Switch
Supervisory controlled for maintenance or set-up.</p> <p><input type="checkbox"/> Multiple Operator Stations Control
Keyed selector switch on/off mounted on control panel to turn additional operator stations on/off.</p> <p><input type="checkbox"/> Bar Turnover Function
Permits manual rotation of the flywheel with the clutch engaged for die setting. Controlled by keyswitch on/off.</p> <p><input type="checkbox"/> Open Space Inside Control Panel
For mounting additional customer supplied components.
Specify desired space:
_____ X _____</p> <p><input type="checkbox"/> Console Mounted Controls
Consult factory for specifics.</p> <p><input type="checkbox"/> Die Block Receptacle Outlet
Female receptacle for an electrical interlock on a die block.</p> <p><input type="checkbox"/> 110VAC Outlet
Panel mounted 110VAC outlet for powering lights, press auxiliary equipment etc.</p> <p><input type="checkbox"/> 220VAC Outlet
Panel mounted 220VAC outlet for powering lights, press auxiliary equipment etc.</p> <p><input type="checkbox"/> Shut Down Timer
Automatically shuts off the punch press when not in use. Length of time is customer adjustable.</p> <p><input type="checkbox"/> Hydraulic Overload
Press will stop when output opens, then allows the press to be moved in the inch mode with the input still open.</p> <p><input type="checkbox"/> Part# 30-012
24VDC @ 2.2 A power(90-26 VAC in)
3.9" Long x 3.8" Wide x 1.4" High (99 mm x 96 mm x 35.6 mm) for powering sensors, or other auxiliary devices.</p> | <p>Qty. <input type="checkbox"/> Clutch-Brake Time Delay HUB Option
Provides the control with a separate relay for the CLUTCH and a separate relay for the BRAKE to allow for a time delay between each, and to be control reliable. Consists of the following:
(1) Safety HUB (Part# 53-448 running the Clutch-Brake program
(1) 24VDC Power Supply (Part#30-012)
(2) Safety Relays for HUB channel D (Part# 52-278)</p> <p><input type="checkbox"/> Peak Tonnage Monitoring (check option below)</p> <p><input type="checkbox"/> T1 - One channel monitoring with strain sensor and cable.</p> <p><input type="checkbox"/> T2 - Two channel monitoring with strain sensors and cables.</p> <p><input type="checkbox"/> T3 - Three channel monitoring with strain sensors and cables.</p> <p><input type="checkbox"/> T4 - Four channel monitoring with strain sensors and cables.</p> <p><input type="checkbox"/> Signature Tonnage Analysis Monitoring
Requires Touchscreen Part #39-151 (check option below)</p> <p><input type="checkbox"/> T1-S - One channel monitoring with strain sensor and cable.</p> <p><input type="checkbox"/> T2-S - Two channel monitoring with strain sensors and cables.</p> <p><input type="checkbox"/> T3-S - Three channel monitoring with strain sensors and cables.</p> <p><input type="checkbox"/> T4-S - Four channel monitoring with strain sensors and cables.</p> <p><input type="checkbox"/> Safety Light Curtain
Model SS Solid State Outputs Safety Light Curtain
Specify Size - 4" (101mm) to 64" (1625mm) guarded zone in 4" (101mm) increments.</p> <p><input type="checkbox"/> 4 <input type="checkbox"/> 8 <input type="checkbox"/> 12 <input type="checkbox"/> 16 <input type="checkbox"/> 20 <input type="checkbox"/> 24</p> <p><input type="checkbox"/> 28 <input type="checkbox"/> 32 <input type="checkbox"/> 36 <input type="checkbox"/> 40 <input type="checkbox"/> 44 <input type="checkbox"/> 48</p> <p><input type="checkbox"/> 52 <input type="checkbox"/> 56 <input type="checkbox"/> 60 <input type="checkbox"/> 64</p> <p><input type="checkbox"/> Shut Height Monitor
Requires interface board Part# 52-298
Choose a length below: A magnet and two mounting brackets are supplied standard with all linear sensors.</p> <p><u>Size</u></p> <p><input type="checkbox"/> 4" - Part# 40-009</p> <p><input type="checkbox"/> 8" - Part# 40-010</p> <p><input type="checkbox"/> 12" - Part# 40-011</p> <p><input type="checkbox"/> 16" - Part# 40-012</p> <p><input type="checkbox"/> 24" - Part# 40-013</p> <p>Consult factory for longer lengths.</p> |
|------------------------------------------------------------------------------------------------------------------------------------------------------------------------------------------------------------------------------------------------------------------------------------------------------------------------------------------------------------------------------------------------------------------------------------------------------------------------------------------------------------------------------------------------------------------------------------------------------------------------------------------------------------------------------------------------------------------------------------------------------------------------------------------------------------------------------------------------------------------------------------------------------------------------------------------------------------------------------------------------------------------------------------------------------------------------------------------------------------------------------------------------------------------------------------------------------------------------------------------------------------------------------------------------------------------------------------------------------------------------------------------------------------------------------------------------------------------------------------------------------------------------------------------------------------------------------------------------------------------------------------------------------------------------------------------------------------------------------------------------------------------------------------------------------------------------------------------------------------------------------------------------------------------------------------------------------------|-----------------------------------------------------------------------------------------------------------------------------------------------------------------------------------------------------------------------------------------------------------------------------------------------------------------------------------------------------------------------------------------------------------------------------------------------------------------------------------------------------------------------------------------------------------------------------------------------------------------------------------------------------------------------------------------------------------------------------------------------------------------------------------------------------------------------------------------------------------------------------------------------------------------------------------------------------------------------------------------------------------------------------------------------------------------------------------------------------------------------------------------------------------------------------------------------------------------------------------------------------------------------------------------------------------------------------------------------------------------------------------------------------------------------------------------------------------------------------------------------------------------------------------------------------------------------------------------------------------------------------------------------------------------------------------------------------------------------------------------------------------------------------------------------------------------------------------------------------------------------------------------------------------------------------------------------------------------------------------------------------------------------------------------------------------------------------------------------------------------------------------------------------------------------------------------------------------------------------------------------------------------------------------------------------------------------------------------------------------------------------------------------------------------------------------------------------------------------------------------------------------------------------------------------------------------------------------------------------------------------------------------------------------------------------------------------------------------------------------------------------------------------------------------------------|

PressCommander Proposal/Ordering Guide

Resolver Based Controls (For Standard Display models)

Additional Die Protection Inputs and PLS (programmable limit switch outputs) for all models.

- Expander Board #52-279**
Adds additional 6 Die inputs and 6 Dry relay contact outputs (At time of order) - Increases the Press Commander die protection from six (6) to twelve (12) station die protection. Also increases the PressCommander programmable limit switch capacity from six (6) to twelve (12) programmable limit switches with mechanical relay (dry) outputs.
- Expander power supply board #52-280 (At time of order)**
Power Supply Board that stacks under the PressCommander Expander Board (52-279) and is required to power the Expander Board functions.

Request Both Part Numbers (52-279 and 52-280) at time of order if expansion is desired.

For Models that utilize the Standard Display

- Remote Master Control Station**
(Free standing operator control station) PressCommander Standard Display Extender System. Moves all the switchgear and the standard display unit into a separate 12" x 14" x 8" box that can be placed closer to the operator. The control boards, optional starter(s), optional disconnect remain in a separate control panel whose size is dictated by the size of the starter(s) & disconnect.
NOTE: Cables are available in 15', 25', 35', and 50' lengths. These cables should never be cut between the Remote Master Control Station and control panel. 15' cable is supplied standard for the Standard Display remote mater control station.
- Extension Cables for Remote Master Control Stations located over 15' (4.5m) with Standard Display from control panel.**
- Part# 53-456 is a 25' Remote Standard Display Extender System
(when the Standard Display unit is located 25' from the PressCommander Board Stack)
 - Part# 53-457 is a 35' Remote Standard Display Extender System
(when the Standard Display unit is located 35' from the PressCommander Board Stack)
 - Part# 53-458 is a 50' Remote Standard Display Extender System
(when the Standard Display unit is located 50' from the PressCommander Board Stack)
- Part #35-111 Ethernet option for the PressCommander Standard Display**

PressCommander Proposal/Ordering Guide

Resolver Based Controls (For Touchscreen Display models)

Part# 39-151
10.1" color touchscreen replaces the Standard PressCommander four line vacuum florescent display. Available for all PressCommander models. Includes Downtime and Production Monitoring System.

Remote Master Control Station with 10.1" color touchscreen
Moves all the switchgear and the touchscreen until into a separate 12" x 14" x 8" box that can be placed closer to the operator. The control boards, optional starter(s), optional disconnect remain in a separate control panel whose size is dictated by the size of the starter(s) and disconnect. This requires the Ethernet option to be installed on the Touchscreen.

Part# 43-027 (Required)
Ethernet cable to connect the Remote Master Control 10.1" color touchscreen to the control panel that contains the control boards, optional starters and disconnects.
Specify length needed in feet. _____

Touchscreen Downtime and Production Monitoring for Overall Equipment Effectiveness (OEE).

Requires Touchscreen Part# 39-151
20 Downtime Codes - Downtime codes are user programmable and customized to need. Downtime codes can be activated either by touching the appropriate touchscreen button **OR** Automatically via the machine circuit signal that induced the machine to stop. This capability provides an exceptional granular fault cause for machine operational analysis.
Production Monitoring is supplied standard with the Touchscreen.

If machine induced automatic signalling is desired to activate a specific downtime code (such as die protection, tonnage monitoring, shortfeed, misfeed etc.) One of the following input/output interface boards are required.

Part# 52-320
Provides the capability for six (6) downtime codes to be activated automatically by existing machine control electrics.

Part# 52-321
Provides the capability for sixteen (16) downtime codes to be activated automatically by existing machine control electrics.

*Note - Part# 52-320 and 52-321
Includes six (6) dry contact relays that can be used to signal stack lights, alarms etc.
Relay Ratings: 5A @ 250 VAC • 5A @ 30 VDC • Coil: 12 VDC

Additional Die Protection Inputs and PLS (programmable limit switch outputs) for all models.

Expander Board #52-279
Adds additional 6 Die inputs and 6 Dry relay contact outputs (At time of order) - Increases the Press Commander die protection from six (6) to twelve (12) station die protection. Also increases the PressCommander programmable limit switch capacity from six (6) to twelve (12) programmable limit switches with mechanical relay (dry) outputs.

Expander power supply board #52-280 (At time of order)
Power Supply Board that stacks under the PressCommander Expander Board (52-279) and is required to power the Expander Board functions.

Request Both Part Numbers (52-279 and 52-280) at time of order if expansion is desired.

Replacement Parts for PressCommander Resolver Based Controls (All Models/Styles)

REPLACEMENT PARTS LISTING

Part Number	Description
11-157	Panel Mount (with Gasket)
11-167	Shield cover for Display unit
11-168	Shield cover for master/slave/power board stack
20-022	1A Slo-Blo nano SMF fuse
20-023	5A Fuse (white nano)
26-091	Display Overlay
30-009	Tonnage Controller (3 or 4 channel)
30-010	Tonnage Sensor & 35' of cable
30-013	Tonnage Controller (1 or 2 channel)
32-002	Output Relay (black G6B-1174P)
32-006	Output Relay (black G6B-2114P)
32-101	4 pole 12 VDC (clear KACO safety relay)
35-111	Ethernet Module with software (factory installed & replaced)
35-065	EEPROM Job memory chip (100 jobs) (59 jobs with optional expander board)
35-120	Job memory chip for the PressCommander only (150 jobs) (100 jobs with optional expander board)
37-040	Solid State output relay (factory installed and replaced)
39-151	10.1" color touchscreen
39-084	RUN/PROG keyswitch, key, and cable
45-020	Resolver cable (30') with connectors
45-027	Display data/power cable (6' standard size)
45-029	Display data/power cable (15' extended length for remoting Display unit)
52-227	Resolver unit (no cable) (formerly 40-003)
52-245	PCS Display board (with job memory and VFD display)
52-246	PCS Master board
52-247	PCS Slave board
52-248	PCS Power supply / Relay output board (with relays and fuses)
52-251	Ribbon Cable Assembly
52-271	Master/Slave 9 conductor Input Cable (4.5')
52-279	Expander Board (requires DeviceNet Plug on back of Display Unit)
52-280	Expander Power supply (stacks under Expander board)

Rotary Cam Based Punch Press Controls

This platform of punch press controls utilizes a rotary cam limit switch with drive check for the machine's position and timing signals.



Pressroom  *Electronics*™

Rotary Cam Based Punch Press Controls Overview



The Model 3200SS (Solid State) Control System is completely prewired and ready for installation. System supplied complete with a well marked terminal strip for easy, safe, and accurate electrical interface to the various punch press components. Due to the hybrid design characteristics of the 3200SS, a main power disconnect switch and magnetic motor starters can be supplied in the same control panel. Complies with section 1910.217 of the Federal Register and ANSI B11.1-2009.

Utilizes a rotary cam limit switch (shown) for the machine timing signals.

All of the listed SSM products below meet or exceed 1910.217 of the Federal Register and ANSI B11.1-2009.

Part Number	Description
SSM-05	3200SS (Boards Only) Clutch/Brake System with remote status display
SSM-08	3200SS (Boards Only) Clutch/Brake System with remote status display, IEC switches, push buttons and legend plates
SSM-10	3200SS control boards mounted on panel backplate with remote status display
SSM-20	3200SS control boards mounted on panel backplate with remote status display, switches, push buttons
3200SS	3200SS control boards with NEMA12 (IP64) control panel with IEC switchgear
3200SS with 1500 Package	3200SS with NEMA12 (IP64) control panel with IEC switchgear and control package 1500 Control Package 1500 includes the following: No. 303A Dual Solenoid Valve with Muffler No. 306B heavy duty pressure switch No. 310A Rotary Cam (4) with sprockets and Chain BM-1600 encoder added if BM-1600 is ordered No. 311 Filter, Regulator, Lubricator No. UL-501 Operator Station

ROTARY CAM LIMIT SWITCHES

Part Number	Model Number	Description
21-082	310A	4 Cam, Rotary Cam Limit Switch (with drive check)
21-089	310E	6 Cam, Rotary Cam Limit Switch (with drive check)
21-090	310G	8 Cam, Rotary Cam Limit Switch (with drive check)
21-091	310A-MD	4 Cam, Rotary Cam Limit Switch (with drive check & encoder)
21-092	310E-MD	6 Cam, Rotary Cam Limit Switch (with drive check & encoder)
21-093	310G-MD	8 Cam, Rotary Cam Limit Switch (with drive check & encoder)

Note -- IEC switchgear supplied standard (NEMA optional). Adder to replace standard IEC switchgear with NEMA switchgear.

*Please note that when punch press timing signals are generated by Rotary Cam or Limit Switches, it is required to have a "time based brake monitor." The time based brake monitor is to measure the press stopping time on each stroke. If the subject press that is being updated with controls does not have a time based brake monitor, add the Model BM-1600 Time Based Brake Monitor to the press control.

Various Models of the Rotary Cam Based Punch Press Controls

SSM-05



The Board Only Clutch/Brake Module (Part #SSM-05). The redundant clutch/brake punch press control module with a remote panel mount message display (available in English or Spanish). Please see the design criteria and system description writing. Complies with section 1910.217 of the Federal Register and ANSI B11.1-2009.

Part #SSM-05 includes:

- Master Board
- Slave Board
- Power Supply Board
- Diagnostic Message Display
- Connecting Cables
- Cover/Hardware
- Software (Master) microprocessor
- Software (Slave) microprocessor

SSM-08



The redundant clutch/brake punch press control module with a remote panel mount message display (available in English or Spanish). Please see the indepth design criteria and system description writing. Complies with section 1910.217 of the Federal Register and ANSI B11.1-2009. Also included are all of the switches, legend plates, push buttons, and indicator lights for easy mounting into your existing control.

Part #SSM-08 includes:

- Master Board
- Slave Board
- Power Supply Board
- Diagnostic Message Display
- Connecting Cables
- Cover/Hardware
- Software (Master) microprocessor
- Software (Slave) microprocessor

Push buttons & legend plates for:

- System start
- System stop
- Automatic continuous set-up

Indicators & legend plates for:

- System on
- Ground fault
- Brake monitor
- Interrupted stroke provision

SSM-10



Small in Size -- Big in Safety and Control
Excellent for the Rebuilder or O.E.M. to install into existing control panel
The redundant clutch/brake punch press control module has a remote panel mount message display (available in English or Spanish). Please see the in-depth design criteria and system description writing. Complies with section 1910.217 of the Federal Register and ANSI B11.1-2009.

SSM-20



The Short Stack Plus (Part #SSM-20) encompasses all of the features and components of the SSM-10 (see page 24 for complete list of features) plus all of the following switches, legend plates, push buttons, and indicator lights for easy mounting into your existing control panel. Complies with section 1910.217 of the Federal Register and ANSI B11.1-2009.

Part #SSM-20 includes:

Keyed selector switches and legend plates for:

- Hand/foot mode
- Off/inch/single/continuous

Push buttons and legend plates for:

- System start
- System stop
- Automatic continuous set-up

Indicators and legend plates for:

- System on
- Ground fault
- Brake monitor
- Interrupted stroke provision

Various Models of the Rotary Cam Based Punch Press Controls 3200SS



NEMA 12 Enclosure

System Start

Guarded Push Button
(Air and Power Interlock)

System Stop

Unguarded Push Button

System On

Indicator Light

Message Display

Plain English messages for status and system self-diagnostics

Continuous Arm Timer Fused Secondary Pressure Clamp Terminals

Hand/Foot Mode

2 Position Keyed Selector for Hand or Foot Mode Initiation

The Model 3200SS (Solid State) control system is completely pre-wired and ready for installation. System supplied complete with a well marked terminal strip for easy, safe and accurate electrical interface to the various punch press components. Complies with section 1910.217 of the Federal Register and ANSI B11.1-2009.

Due to the hybrid design characteristics of the 3200SS, a main power disconnect switch and magnetic motor starters can be supplied in the same control panel.

Customer to specify operator control location (photo below displays operator controls on panel door).

Interrupted Stroke Provision with Indicator

If the punch press is in the single stroke or continuous mode and the press stops before the completion of a full stroke, the Interrupted Stroke Provision is activated. The control will automatically switch to the inch mode and the palm buttons must be used to return the ram to the top of the stroke. When back at the top, the control automatically switches back to the original operational mode setting and the operator may resume normal production. The Interrupted Stroke Provision improves productivity and safety significantly by eliminating the need for the operator to make mode selection adjustments on interrupted strokes.

Automatic Continuous Set Up Push Button

This prior action push button must be operated to set-up the press for continuous operation. Once depressed, the operator has a preset length of time in which to depress both palm buttons concurrently to initiate operation in the continuous mode.

LED Diagnostics

Punch Press Components and System Diagnostics with LED Indicator Lights, on printed circuit boards for all inputs and outputs.

Brake Monitor--Top Stop Indicator

Oil tight indicator light to detect top stop overrun, this light is tied into the rotary cam to provide an electro-mechanical brake monitoring system. Time-based brake monitoring optional.

Ground Fault Detector

Oil tight push to test type wired to continuously monitor press grounding whenever control power is on.

Transformer

To reduce voltage from 480/240V to 120 VAC secondary. Consult factory for 208 or 550 volt system.

Keyed Mode Selector Off-Inch-Single Continuous

4 position keyed lock selector switch for supervised selection of mode of operation of the press. When in the inch mode the operator cannot hold or tie one run button down and use the other button to inch the press with one hand operation. Both buttons must be depressed concurrently. Micro-Inching and Automatic External Trip optional.

Feature Listing for SSM-10 and SSM-20:

- Control reliable redundant control module
- Diagnostic Message Display
- Fused transformer
- Control module pre-wired to terminal strip
- Pressure clamp terminal strip
- Mounted on a 17" (432mm) x 18" (457mm) backplate
- Wiring diagram and complete installation instructions supplied
- Modes of operation off – inch – single – continuous
- Continuous ARM
- Top stop
- Anti-tie down and anti-repeat
- System start/stop functions
- SPM Range - 1 to 500
- Control reliable design
- Interrupted stroke provision with indicator

- Inch mode monitoring
- Control module provides anti-tie down and concurrency function for up to four sets of operator stations
- Light curtain mute-out on upstroke standard
- Clutch/brake module designed to fit into tight spaces. Printed circuit board dimensions; only 6.5" (165mm) x 5" (127mm) x 4" (102mm) including standoff.
- Control systems are captively designed, manufactured, and supported.
- Self-contained plain English message display
- Self-diagnostic system
- The control module monitors the signals and circuits as specified by OSHA and ANSI standards
- Control incorporates dual logic power supplies
- Two-year warranty on control module

Rotary Cam Based Punch Press Controls with Components

1500SS Package



Incorporates all the requirements of OSHA for control reliability and component monitoring. Also includes component and system diagnostics with indicator lights for total press monitoring. Complies with section 1910.217 of the Federal Register and ANSI B11.1-2009.

When foot actuation is used, a method of guarding the point of operation must be provided. Refer to OSHA/ANSI requirements.

Features

- Model 3200SS Control Panel
- Expandable
- Brake Monitor
- Two Hand Anti-Tie Down
- System Control Reliability
- Single Stroke
- Self-diagnostic system
- Self-contained message display for system status and diagnostics
- Non-Resumption of interrupted stroke
- Provisions for Auxiliary Equipment
- PSDI Presence Sensing Device Initiation
- Two-Year Warranty

The control panel 3200SS is included in the 1500SS Package.

1500SS Package includes the following components:



Dual Solenoid Valve

The dual solenoid valve is monitored and contains a pressure controlled spool in an assembly mounted between the pilot and valve body assemblies. Pressure signals are applied to each end of the monitor spool. If these signals differ by more than a built-in design limit, they cause the spool to shift to a latched position. The spool movement causes the pilots to be exhausted and pilot supply air to be vented to the atmosphere, thus rendering the valve inoperable. The monitor must be reset by unlatching the spool before another valve cycle can be initiated.



Operator Station

No. UL-501 Two Ergonomic UltraTouch modules mounted on a NEMA 12 operator station run bar with a red mushroom emergency stop button located in the center and a yellow mushroom top stop button located off center. This style assembly is ideal for the metal stamping/metal fabrication industry. All the modules are mounted in accordance to OSHA, ANSI, and CSA standards in regards to run button spacing.



Heavy Duty Pressure switch No. 306

This NEMA 12 oil-tight and dust-tight switch is adjustable from 1 to 115 PSI.



Filter Regulator Lubricator No. 311



Rotary Cam Switch with Drive Check No. 310A

This NEMA 12 rotary switch provides limit switch functions required by control system. Spring-loaded mounting absorbs shock and will stop the press should the drive chain break. Cams are easily adjusted with tool provided.

Rotary Cam Based - Punch Press Controls Options

Description

- Fused main power Disconnect (IEC or NEMA)
- Magnetic motor starters (IEC or NEMA)
- Rotary Cam Limit Switches
- 54-003 - Model BM-1600 Time Based Brake Monitor mounted in a control panel (with encoder)
- Micro-Inching function
- Light Guard on/off supervisory controlled key switch (IEC)
- Multiple operator station control key switch (IEC)
- Bar Turnover function (IEC)
- Die Block receptacle outlet
- Shutdown timer
- 110VAC outlet
- 220VAC outlet (specify load)
- 5 Digit resettable LCD counter (battery powered) 2.8" x 1.5" (Part Number 39-026)
- Remote Operator Interface Panel
- NEMA Style Indicators & Switch gear on control panel to replace IEC Style
- Automatic External Trip
 - SSM-10 without IEC switchgear (at time of purchase)
 - SSM-20 with IEC switchgear (key switches & push buttons)
- Continuous on Demand
 - SSM-10 without IEC switchgear (at time of purchase)
 - SSM-20 with IEC switchgear (key switches & push buttons)

(For Custom Programming & Remote Field Upgrades, please consult factory at service@pressroomelectronics.com or (630) 443-9320.)

GUARDING:

Safety Light Curtain (up to four sets of pylons, specify size)
(see Pinnacle Systems, Inc. website for models)

Rotary Cam Based - Punch Press Controls Replacement Parts

Part Number	Description
11-072	Steel master/slave/power/relay stack cover (white)
20-001	1A Slo-Blo glass 3AG fuse
20-018	1A Fuse (plastic standup micro, in 24vdc output)
20-022	1A Slo-Blo nano SMF fuse
26-016	Diagnostics Status Display label (overlay)
30-012	24vdc @ 2.2A power supply (90-260vac In) 3.9" L x 3.8" W x 1.4" H (99.1mm x 96.5mm x 35.6mm)
32-101	4 pole 12 VDC (clear KACO safety relay)
39-026	Standalone five digit counter with reset.
42-004	Master software Chip (please note rectangular or square)
42-005	Slave software Chip (please note rectangular or square)
52-032	Diagnostics Status Display unit
52-071	Ribbon cables
52-093	Master/Slave 12 conductor Input Cable (52") Double ended female
52-119M	Master computer board (no CPU)
52-119S	Slave computer board (no CPU)
52-120	Power supply/Relay board (with relays)

Rotary Cam Based Punch Press Control Ordering Guide

Please complete the form on the next two pages and email it to the Pressroom Sales Department at sales@pressroomelectronics.com. You may also fax the form to (412) 262-1197. We also have an electronic version of this form available on our website www.pressroomelectronics.com.

Name	_____	Email	_____
Company	_____	Punch Press Manufacturer	_____
Address	_____	Model #	_____ Serial # _____
City	_____	Shop #	_____ Press Speed (SPM) _____
State	_____ Zip _____	Voltage	_____ Cycle _____ Phase _____
Phone	_____	Fax	_____

Rotary Cam Based OEM and Rebuilder Clutch / Brake Controls

Please provide quantity next to desired option(s).

Specify operator control location. Please check one:

Left End (LE) Panel Door (PD) Right End (RE)

Qty. <input type="checkbox"/> Board Only Clutch / Brake System (SSM-05)	Qty. <input type="checkbox"/> Control Package 1500SS (Solid State) NEMA 12 Enclosure with IEC switchgear
<input type="checkbox"/> Board Only Clutch / Brake System (SSM-08) with IEC Switches, push buttons and legend plates	<input type="checkbox"/> The Ultimate (Model 3200SS with PressCam8) NEMA 12 Enclosure with IEC switchgear
<input type="checkbox"/> Short Stack (SSM-10)	<input type="checkbox"/> PressCommander (Resolver Based) NEMA 12 Enclosure with IEC switchgear
<input type="checkbox"/> Short Stack Plus (SSM-20) with IEC switchgear	
<input type="checkbox"/> Model 3200SS (Solid State) Control Systems NEMA 12 Enclosure with IEC switchgear	

Customized Control Panel Options

Using Model 3200SS Control System as a base. Please provide quantity next to desired option(s).

Qty. <input type="checkbox"/> Fused Main Power Disconnect Mounted on control panel _____ AMP Choose Style: IEC NEMA	Qty. <input type="checkbox"/> Accessory Magnetic Motor Starter Choose Style: IEC NEMA Choose: Rev Non-Rev _____ HP _____ Full Load Amps Includes on/off push buttons and keyed selector switch forward/reverse when applicable.
<input type="checkbox"/> Main Motor Magnetic Motor Starter Choose Style: IEC NEMA Choose: Rev Non-Rev _____ HP _____ Full Load Amps Includes on/off push buttons and keyed selector switch forward/reverse when applicable.	<input type="checkbox"/> Time Based Brake Monitor (front panel mounted)
<input type="checkbox"/> Ram Adjust Magnetic Motor Starter Choose Style: IEC NEMA _____ HP _____ Full Load Amps Includes up/down push buttons and keyed selector switch forward/reverse when applicable.	<input type="checkbox"/> Micro-Inching Feature
	<input type="checkbox"/> Continuous On Demand
	<input type="checkbox"/> Automatic External Trip
	<input type="checkbox"/> Light Curtain Interface Keyed selector switch on/off mounted on control panel for light curtain.

Rotary Cam Based Punch Press Control Ordering Guide

Qty.

Multiple Operator Stations Control
Keyed selector switch on/off mounted on control panel to turn additional operator stations on/off.

Bar Turnover Function
Permits manual rotation of the flywheel with the clutch engaged for die setting. Controlled by keyswitch on/off.

Open Space For Inside Control Panel
Four mounting additional customer supplied components.
Specify desired space: _____ x _____

Remote Master Control Station
Moves all the switchgear and Display unit into a separate 12" x 14" x 8" box that can be placed closer to the operator. The control boards, optional starter(s), optional disconnect remain in a separate Control panel whose size is dictated by the size of the starter(s) & disconnect. NOTE: There is a 15' cable length limitation between the Remote box and Control panel.

Model BM-1600
Time Based Brake Monitor

Custom Programming & Remote Field Upgrades
Email service@pressroomelectronics.com or call (630) 443-9320.

Additional Options
Please specify additional options that are desired, but not listed.

Qty.

Console Mounted Controls
Consult factory for specifics.

Die Block Receptacle Outlet
Female receptacle for an electrical interlock on a die block.

110 VAC Outlet
Panel mounted 110 VAC outlet for powering lights, press auxiliary equipment etc.

220VAC Outlet
Panel mounted 220VAC outlet for powering lights, press auxiliary equipment etc.

Shutdown Timer
Automatically shuts off the punch press when not in use. Length of time is customer adjustable.

Counter
Resettable five digit numerical counter mounted on control panel.

Safety Light Curtain (SLC)
Model SS Solid State Outputs
Specify Size - 4" (101mm) to 64" (1625mm) guarded zone in 4" (101mm) increments.

- 4 8 12 16 20 24
- 28 32 36 40 44 48
- 52 56 60 64

Additional Comments or Questions

Product Photos and Descriptions

For additional information on all products listed, please visit our website www.pressroomelectronics.com.



SSM-05



SSM-10



PressCommander
Resolver Based



SSM-08



SSM-20



Model 320SS
Rotary Cam
Based



The Ultimate

Time Based Brake Monitoring and Time Based Linear Stopping Performance Monitors

For Rotary Applications

Model BM-1600 incorporates a rotary encoder for rotating shaft based machinery such as air clutch/brake power presses. Complies with OSHA 29 CFR 1910.217 and ANSI B11.1-2009 safety requirements for brake monitoring of mechanical power presses.

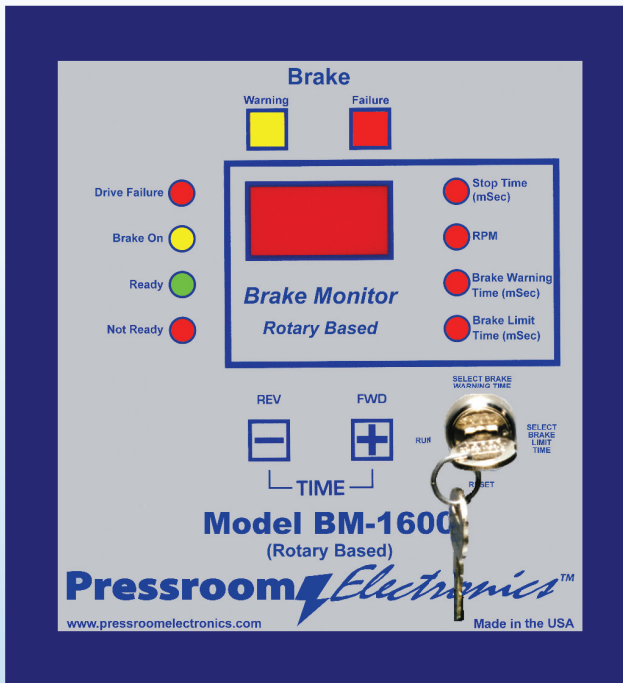

Front Panel Mounting Shown

For Linear Applications

Model LT-1900 incorporates a linear transducer for measuring the stopping time of pneumatic and hydraulic presses and machinery. Complies with ANSI B11.2-2013 requirements for hydraulic and pneumatic power presses and complies with ANSI B11.3-2012 stopping performance monitoring requirements for power press brakes.

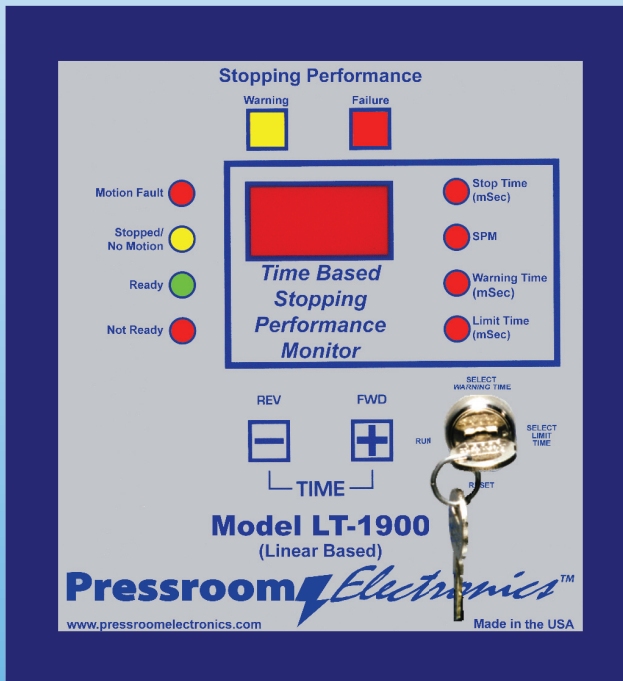



Front Panel Mounting Shown

Time Based Brake Monitor Model BM-1600 with Rotary Encoder for Air Clutch/Brake Power Presses

Brake

Warning Failure

 

Drive Failure 

Brake On 

Ready 

Not Ready 



Brake Monitor
Rotary Based



Stop Time (mSec) 

RPM 

Brake Warning Time (mSec) 

Brake Limit Time (mSec) 

REV FWD

TIME

RUN SELECT BRAKE WARNING TIME SELECT BRAKE LIMIT TIME

RESET



Model BM-1600
(Rotary Based)

Pressroom  *Electronics*™

www.pressroomelectronics.com Made in the USA

Time Based Brake Monitor/Stopping Performance Monitor

Model BM-1600 (Rotary Encoder Based)

Brake Warning Indicator

Yellow light illuminates when the setpoint is exceeded. Excellent input for the press operator and for maintenance.

Drive Failure

Red LED illuminates when the pulses from the encoder disappear while the brake remains released.

Brake On

Yellow LED illuminates when power to the dual solenoid valve drops out.

Ready

Green LED illuminates when all systems are go.

Not Ready

Red LED illuminates when the brake monitor safety relays have dropped out (i.e., drive failure, internal failure, etc.)

+/- Pushbuttons

The +/- pushbuttons are used to set the time values in milliseconds for the brake warning and the brake limit setpoints.

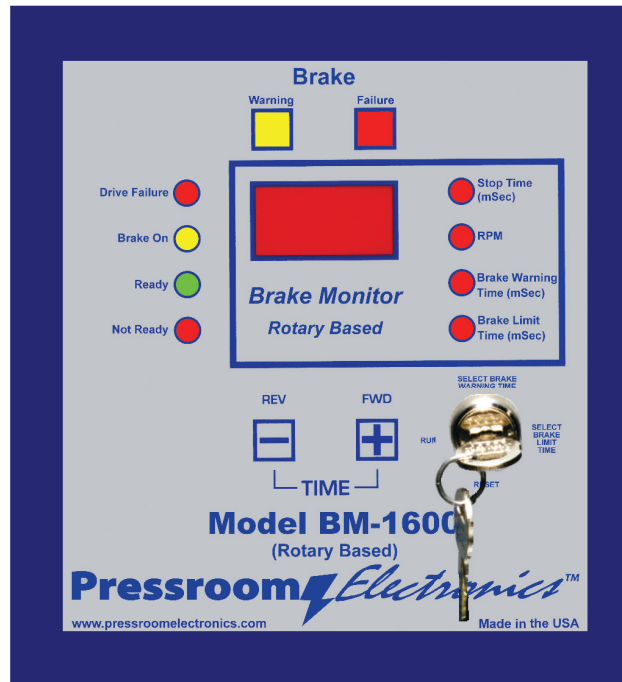

Brake Failure Indicator

Red LED illuminates when the actual brake stopping time exceeds the programmed brake limit setpoint.

Stop Time

Displayed in milliseconds after every stop in machine cycle and the red LED is illuminated.

RPM/SPM

Displayed during each press cycle when the red LED is illuminated.

Brake Warning Time

Displayed in milliseconds when the red LED is illuminated.

Brake Limit Time

Setpoint is displayed in milliseconds when the red LED is illuminated.

System Programming Security and Safety

Keyed selector switch controls:

- Brake Warning Time Setpoint
- Brake Limit Time Setpoint
- System Reset
- System Run

How the BM-1600 Brake Monitor Works

The BM-1600 is a time based brake monitor that utilizes a high resolution rotary encoder and controller to measure the brake stopping time in milliseconds and also the RPM/SPM of the press. The rotary encoder is attached to the subject machine and is driven on a 1:1 ratio by the power press crankshaft. The brake stopping time of the machine will be displayed on every stop and can be easily read on the bright red light emitting diode (LED) display on the front panel of the unit. The RPM/SPM of the machine will be displayed during the machine cycle.

Individual LED indicators are visible and easily define the existing status of the unit during the press cycle (shown above). All system programming and diagnostics are front panel mounted and controlled which will minimize downtime while enhancing operator safety and press maintenance. All operating mode selections are supervisory controlled by a keyed

selector switch which meets all OSHA and ANSI standards for mode selection supervisory control.

To program the Brake Warning Time and the Brake Limit Time setpoints, the user inserts the programming key into the lock and turns to the desired position (status LED illuminates). By depressing the +/- buttons to the desired time setting and turning the key back to the Run position, the new warning/failure time setpoints are saved. All errors and time value setpoints are permanently stored in the EEPROM memory which does not require a battery backup. The user cannot change or reprogram the Brake Warning or Brake Limit setpoints while the encoder is in motion, which is an additional safety feature.

The dual force-guided captive contact safety output relays of the BM-1600 are always de-energized when the

programming key is not in the Run position. When the key is in the Run position, the safety output relays are always energized as long as there are no internal or external faults detected. When a fault is detected, it is recorded within the system in non-volatile memory along with the last stopping time. If the power to the Brake Monitor System is removed and reapplied, the last error to occur will come back up and prevent any further use until the programming key is used. Only the key turned to the reset position can clear a fault. If no fault occurred but the programming key is moved into the reset position, the output relays will de-energize as a safety feature. Motion detection will still be monitored while in the Reset position even if the encoder is turning.

Time Based Brake Monitor/Stopping Performance Monitor

Model BM-1600 (Rotary Encoder Based)

OSHA/ANSI Compliance

The BM-1600 system complies with OSHA code 29 CFR 1910.217 and ANSI Code B11.1-2009 for brake monitoring and control reliability standards. The unit will automatically prevent the activation of a successive stroke if the stopping time deteriorates beyond the brake limit setpoint. Required on any press that has a single stroke mode and uses either a two-hand control, light curtain or type B gate system.

Non-volatile EEPROM Memory

All diagnostic faults and brake setpoints are permanently saved in non-volatile memory which does not require battery backup. Information is retained indefinitely after a power loss or machine shutdown.

Advanced Design

The advanced circuitry and user

friendly design on the BM-1600 allows both programming and status monitoring to be performed from the front of the compact panel. There is no need to enter the control panel to adjust switches or thumbwheels which will enhance both safety and productivity.

System Self Diagnostics

Control displays status and system fault codes are on the LED display. A detailed definition, cause, and cure listing is supplied within each installation and operation manual.

Predictive Maintenance Diagnostic Tool

The unique "brake warning" feature on the BM-1600 allows for predictive maintenance to be scheduled on the machine, which will minimize downtime. Factors which will be monitored and affect stopping time:

machine cycle speed, counter-balance air supply, tooling weight, clutch air supply, exhaust restrictions, brake wear adjustment, and clutch wear adjustment.

90° and 270° Stop Time Measurement Built-In

The built-in 90° press stop feature initiates a stop signal at the 90° and the 270° position in the downstroke. This is required information when calculating the location of point of operation guarding systems or palm button assemblies.

Complete Package Supplied

Everything you need to install and operate the BM-1600 is supplied.

- BM-1600 Brake Monitor Controller
- Model E-160 Encoder
- 20' (6m) of encoder cable
- Dimensional and technical data
- Installation and operation manual

Standard Features

- Control reliable design
- Dual captive contact safety relays
- Bright red LED display
- Non-volatile EEPROM memory
- Flat unobtrusive design
- Drive failure detection
- Motion detector
- Automatic 90° and 270° press stop
- Programming security with keyed selector switch
- Very easy to program and to adjust limits
- System self-diagnostics with display codes
- External diagnostic display
- System status indicators (LED's)
- Solid state indicators - No incandescent bulbs to burn out
- Designed specifically for the rigorous metal stamping/metal forming industry
- Interfaces easily with all types of press controls; solid state or relay logic
- Installs with ease on OEM, retrofit, or rebuild projects
- Front panel mount for installation into an existing control panel
- Made in USA

Specifications

Controller

Power Requirements - 120 +/- 10% VAC, 50-60 Hz
24 VDC +/- 10% (optional)

Power Consumption - 8 watts (Relays on)

Temperature Range - 0° to 50° Celsius

Relay Configuration - Dual self-checking force-guided captive contact safety relays

Relay Contact Rating

8 amps @ 250VAC resistive for safety relays

4 amps @ 250VAC resistive for alarm relay

System Accuracy - +/- 1 millisecond

Setpoints - Drive Failure (1 to 25 tenths of a second)
Brake Warning (1 to 999 milliseconds)
Brake Failure (1 to 999 milliseconds)

Enclosure - NEMA 12 (IP 64) Steel

Indicators:

Brake Fault - Red LED

Drive Failure - Red LED

Ready - Green LED

Stop Time Display - Red LED

Brake Warning Setpoint - Red LED

Brake Warning - Yellow LED

Brake ON - Yellow LED

Not Ready - Red LED

RPM - Red LED

Brake Limit Setpoint - Red LED

NEMA 12 Enclosure Dimensions -

8" (203mm) Height x 7" (178mm) Width x 4" (102mm) Depth

Front Panel Mount - 8" (203mm) Height x 7" (178mm) Width x 4" (102mm) Depth

Encoder (Part # E-160 — CW or CCW Rotation Capable)

Cable - 20' (6m) supplied standard; 100' (30m) max.

Gauge: 20 AWG - 3 connectors plus drain

Rating: 300 VAC @ 60 C

Shaft Loading - Radial: 35 lbs; Axial: 40 lbs.

Temperature Range - 0° to 50° Celsius

Dimensions - 5.5" (140mm) Height x 3.75" (95mm) Width x 3-9/16 (90mm)

Time Based Brake Monitor/Stopping Performance Monitor

Model BM-1600 (Rotary Encoder Based)



The BM-1600 is a time-based brake monitor that utilizes a high resolution rotary encoder and controller to measure the brake stopping time in milliseconds and also the RPM of the press. The rotary encoder is attached to the subject machine and is driven on a 1:1 ratio by the power press crankshaft. The brake stopping time of the machine will be displayed on every stop and can be easily read on the bright red light emitting diode (LED) display on the front panel of the unit. The RPM/ of the machine will be displayed during the machine cycle.

- BM-1600 Brake Monitor System includes:
- BM-1600 controller (BM)
 - E-1600 Encoder (supplied standard)
 - 20' (6m) encoder cable
 - Dimensions and technical data
 - Installation and operation manual

- BM-1600D Brake Monitor System and Dual-Shaft Encoder System includes:
- BM-1600D controller (BMD)
 - EN-1600D Dual-Shaft Encoder
 - 20' (6m) encoder cable
 - Dimensions and technical data
 - Installation and operation manual



BM-1600 in NEMA 12 (IP 64) steel enclosure.

ORDERING PROCEDURE FOR BM-1600

1. Select **BM** or **BDM** for encoder style
2. Specify Mounting Style
 - E** Front Panel Mounting to be installed in an existing control panel.
 - C** Stand alone NEMA12 (IP 64) steel enclosure.
3. Specify Controller input power
 - 1** 24VDC
 - 2** 120VAC 50-60Hz
 - 3** 240VAC 50-60Hz
4. Specify Clutch/Brake Valve Coil Voltage
 - 1** 24VDC
 - 2** 120VAC 50-60Hz
5. Encoder Connector Cable
 - 20' (6m) is supplied standard. If additional length is needed, specify in feet. 100' (30m) max.

EXAMPLE PART NUMBER

BM	-	C	-	2	-	2	-	20
<u>BM-1600</u>		<u>Mounting Style</u>		<u>Input Power</u>		<u>Clutch/Brake Valve Voltage</u>		<u>Encoder Cable (in feet)</u>
or <u>BMD</u> for dual shaft encoder.								

Time Based Brake Monitor/Stopping Performance Monitor



Model BM-1600 (Rotary Encoder Based) Replacement Parts





REPLACEMENT PARTS LISTING OF MODEL BM-1600





Part Number	Description
11-001	Metal box enclosure (with gasket)
11-073	Metal panel mount (with gasket) open frame for brake monitor
20-001	1A Slo-Blo glass 3AG fuse
20-022	1A Slo-Blo nano SMF fuse
21-053	Encoder Wheel (brass)
26-020	Front panel overlay (BM-1600)
42-001	Software microprocessor chip (specify square or rectangular)
43-004	Encoder cable (20')
52-002	Display board
52-003	Computer / Power supply / Relay board (with CPU)
52-084	Ribbon Cable
52-202	Encoder board
53-004	E-1600 Encoder with single-ended shaft (supplied standard)
53-451	EN-1600D Encoder with double-ended shaft

Time Based Linear Stopping Performance Monitor Model LT-1900





Stopping Performance

Warning  Failure 

Motion Fault  Stopped/ No Motion  Ready  Not Ready 

 Stop Time (mSec)  SPM  Warning Time (mSec)  Limit Time (mSec)

Time Based Stopping Performance Monitor

REV  FWD  RUN  SELECT WARNING TIME  SELECT LIMIT TIME  RESET

Model LT-1900
(Linear Based)

Pressroom  *Electronics*TM

www.pressroomelectronics.com Made in the USA

Time Based Stopping Performance Monitor

Model LT-1900 (Linear Based)

Warning Indicator

Yellow light illuminates when the setpoint is exceeded. Excellent input for the machine operator and for maintenance.

Motion Failure

Red LED illuminates when the pulses from the failure disappear.

Stopped/No Motion

Yellow LED illuminates when power to the valve drops out.

Ready

Green LED illuminates when all systems are go.

Not Ready

Red LED illuminates when the monitor safety relays have dropped out (i.e., drive failure, internal failure, etc.)

+/- Pushbuttons

The +/- pushbuttons are used to set the time values in milliseconds for the stopping performance warning and the limit setpoints.

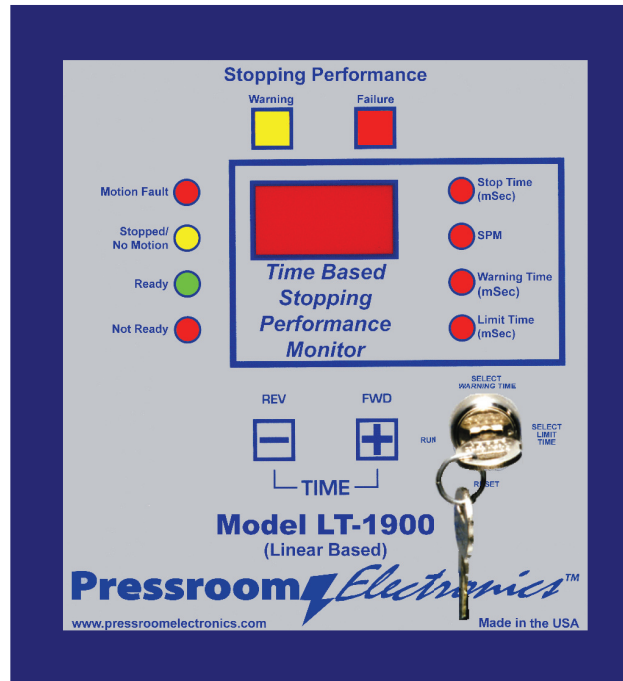

Failure Indicator

Red LED illuminates when the actual stopping time exceeds the programmed stop limit setpoint.

Stop Time

Displayed in milliseconds after every stop in machine cycle and the red LED is illuminated.

SPM

Displayed during each machine cycle when the red LED is illuminated.

Stopping Performance

Warning Time

Displayed in milliseconds when the red LED is illuminated.

Stopping Performance Limit

Time

Setpoint is displayed in milliseconds when the red LED is illuminated.

System Programming Security and Safety

Keyed selector switch controls:

- Warning Time Setpoint
- Limit Time Setpoint
- System Reset
- System Run

How the LT-1900 Stopping Performance Monitor Works

The LT-1900 is a time based stopping performance monitor that utilizes a high resolution linear transducer and controller to measure the machine stopping time in milliseconds and also the SPM of the machine. The linear transducer is attached to the subject machine and is driven on a 1:1 linear ratio by the machine. The stopping time of the machine will be displayed on every stop and can be easily read on the bright red light emitting diode (LED) display on the front panel of the unit. The SPM of the machine will be displayed during the machine cycle. Individual LED indicators are visible and easily define the existing status of the unit during the machine cycle (shown above). All system programming and diagnostics are front panel mounted and controlled which will minimize downtime while enhancing operator safety and machine maintenance. All operating mode selections are supervisory controlled by a keyed

selector switch which meets all OSHA and ANSI standards for mode selection supervisory control. To program the Warning Time and the Limit Time setpoints, the user inserts the programming key into the lock and turns to the desired position (status LED illuminates). By depressing the +/- buttons to the desired time setting and turning the key back to the Run position, the new warning/failure time setpoints are saved. All errors and time value setpoints are permanently stored in the EEPROM memory which does not require a battery backup. The user cannot change or reprogram the Warning or Limit setpoints while the machine is in motion, which is an additional safety feature.

The dual force-guided captive contact safety output relays of the LT-1900 are always de-energized when the

programming key is not in the Run position. When the key is in the Run position, the safety output relays are always energized as long as there are no internal or external faults detected. When a fault is detected, it is recorded within the system in non-volatile memory along with the last stopping time. If the power to the LT-1900 Monitor System is removed and reapplied, the last error to occur will come back up and prevent any further use until the programming key is used. Only the key turned to the reset position can clear a fault. If no fault occurred but the programming key is moved into the reset position, the output relays will de-energize as a safety feature. Motion detection will still be monitored while in the Reset position even if the linear transducer has motion.

Time Based Stopping Performance Monitor

Model LT-1900 (Linear Based)

OSHA/ANSI Compliance

The LT-1900 system complies with OSHA code 29 CFR 1910.217 and ANSI Codes B11.3-2012 and B11.2-2013 for monitoring and control reliability standards. The unit will automatically prevent the activation of a successive stroke if the stopping time deteriorates beyond the brake limit setpoint.

Non-volatile EEPROM Memory

All diagnostic faults and setpoints are permanently saved in non-volatile memory which does not require battery backup. Information is retained indefinitely after a power loss or machine shutdown.

Advanced Design

The advanced circuitry and user friendly design on the LT-1900 allows both programming and status monitoring to be performed from the

front of the compact panel. There is no need to enter the control panel to adjust switches or thumbwheels which will enhance both safety and productivity.

System Self Diagnostics

Control displays status and system fault codes are on the LED display. A detailed definition, cause, and cure listing is supplied within each installation and operation manual.

Predictive Maintenance Diagnostic Tool

The unique "warning" feature on the LT-1900 allows for predictive maintenance to be scheduled on the machine, which will minimize downtime. Factors which will be monitored and affect stopping time: machine cycle speed, air supply, tooling weight, exhaust restrictions, wear adjustment and pressure.

Stop Time Measurement Built-In

The built-in stop feature initiates a stop signal in the downstroke. This is required information when calculating the location of point of operation guarding systems or operator palm button assemblies.

Complete Package Supplied

Everything you need to install and operate the LT-1900 is supplied.

- LT-1900 Controller
- Linear Transducer and Brackets
- Magnet
- 40' (12m) of transducer cable
- Dimensional and technical data
- Installation and operation manual

- Control reliable design
- Dual captive contact safety relays
- Bright red LED display
- Non-volatile EEPROM memory
- Flat unobtrusive design
- Drive failure detection
- Motion detector
- Automatic 90° and stop time tester press stop
- Programming security with keyed selector switch
- Very easy to program and to adjust limits

- System self-diagnostics with display codes
- External diagnostic display
- System status indicators (LED's)
- Solid state indicators - No incandescent bulbs to burn out
- Designed specifically for the rigorous metal stamping/metal forming industry
- Interfaces easily with all types of machine controls; solid state or relay logic
- Installs with ease on OEM, retrofit, or rebuild projects
- Front panel mount for installation into an existing control panel
- Made in USA

Standard Features

Specifications

Controller

Power Requirements - 120 +/- 10% VAC, 50-60 Hz
24 VDC +/- 10% (optional)

Power Consumption - 8 watts (Relays on)

Temperature Range - 0° to 50° Celsius

Relay Configuration - Dual self-checking force-guided captive contact safety relays

Relay Contact Rating

8 amps @ 250VAC resistive for safety relays

4 amps @ 250VAC resistive for alarm relay

System Accuracy - +/- 1 millisecond

Setpoints - Drive Failure (1 to 25 tenths of a second)

Warning (1 to 999 milliseconds)

Failure (1 to 999 milliseconds)

Enclosure - NEMA 12 (IP 64) Steel

Front Panel Mount - 8" (203mm) Height x 7" (178mm)

Width x 4" (102mm) Depth

Indicators:

Fault - Red LED

Motion Fault - Red LED

Ready - Green LED

Stop Time Display - Red LED

Warning Setpoint - Red LED

Warning - Yellow LED

Stopped/No Motion - Yellow LED

Not Ready - Red LED

SPM - Red LED

Limit Setpoint - Red LED

Enclosure rating: NEMA 12, IP 64

Dimensions - .34" (8mm) high, 1.1" (28mm) wide (all lengths)

Active Length - 4" (101mm) active zone - 10.3" (263mm) total length

Active Length - 8" (203mm) active zone - 14.7" (365mm) total length

Active Length - 12" (305mm) active zone - 18.4" (467mm) total length

Active Length - 16" (406mm) active zone - 22.3" (568mm) total length

Active Length - 24" (609mm) active zone - 30.4" (771mm) total length

Mounting Brackets - Supplied standard with each linear transducer

Cable Length - 40' (12m) supplied standard with each linear transducer

Time Based Stopping Performance Monitor

Model LT-1900 (Linear Based)

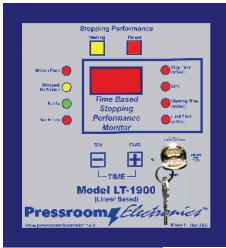

The LT-1900 is a time-based stopping performance monitor that utilizes a high resolution linear transducer and controller to measure the machine stopping time in milliseconds and also the SPM of the press. The linear transducer is attached to the subject machine and is driven on a 1:1 linear ratio by the machine. The machine stopping time of the machine will be displayed on every stop and can be easily read on the bright red light emitting diode (LED) display on the front panel of the unit. The SPM of the machine will be displayed during the machine cycle.

- LT-1900 Stopping Performance Monitor System includes:
- LT-1900 controller (LT)
 - Linear transducer with mounting brackets and magnet
 - 40' (12m) linear transducer cable
 - Dimensions and technical data
 - Installation and operation manual



LT-1900 in NEMA 12 (IP 64) steel enclosure.

ORDERING PROCEDURE FOR LT-1900

1. Specify Mounting Style
 - F** Front Panel Mounting to be installed in an existing control panel.
 - C** Stand alone NEMA12 (IP 64) steel enclosure.
2. Specify Controller input power
 - 1** 24VDC
 - 2** 120VAC 50-60Hz
3. Specify Hydraulic Valve Coil Voltage
 - 1** 24VDC
 - 2** 120VAC 50-60Hz
4. Specify linear transducer length (must equal or exceed maximum machine stroke length)
 - 04** 4" (101mm) active length
 - 08** 8" (203mm) active length
 - 12** 12" (305mm) active length
 - 16** 16" (406mm) active length
 - 24** 24" (609mm) active length

*Over 24" (609mm) stroke required. Consult factory.

EXAMPLE PART NUMBER

LT	-	C	-	1	-	1	-	1	-	08
<u>LT</u> -1900		Mounting Style		Input Power		Signal Voltage		Hydraulic Valve Voltage		Transducer Length (in inches)

Time Based Stopping Performance Monitor

Model LT-1900 (Linear Based) Replacement Parts

Part Number	Description
11-001	Metal box enclosure (with gasket) (NEMA 12, IP 64)
11-073	Metal panel mount (with gasket) open frame for LT-1900
15-079	8 position mini-Euro plug connector (Linear Sensor)
20-001	1A Slo-Blo glass 3AG fuse
20-022	1A Slo-Blo nano SMF fuse
26-101	Front panel overlay (LT-1900)
32-101	Safety relay (4 pole, 12 VDC, clear)
42-001	Software microprocessor chip (specify square or rectangular)
52-002	Display board
52-084	Ribbon Cable
52-202	Transducer board
52-319	Computer / Power supply / Relay board (with CPU)
40-009	4" (10.7" - 272mm total length, 4.3" - 110mm sensor area) linear transducer with 40' (12m) cable
40-010	8" (14.7" - 372mm total length, 8.3" - 210mm sensor area) linear transducer with 40' (12m) cable
40-011	12" (18.4" - 467mm total length, 12" - 305mm sensor area) linear transducer with 40' (12m) cable
40-012	16" (22.5" - 572mm total length, 16.1" - 410mm sensor area) linear transducer with 40' (12m) cable
40-013	24" (30.4" - 772mm total length, 24.0" - 610mm sensor area) linear transducer with 40' (12m) cable
40-014	LT-1900 sensor Magnet (requires 1)
40-015	LT-1900 Sensor Mounting Bracket (requires 2)

Punch Press Automation Controllers

PressCam 8 Junior and PressCam 8



Pressroom  *Electronics*™

Punch Press Automation

Feature Comparison of PressCam 8 Junior and PressCam 8

	PressCam 8™ Junior	PressCam 8™
Diagnostic Display	Vacuum Fluorescent (4 lines/20 characters)	Monochrome LCD Display (8" diagonal screen)
Ease of Programming	Cursor/Key Pad	Tuning Knob
Control Reliable System	No	Yes
Limit Switch Outputs	6	11
Die Protection Inputs	6	16
Number of (non-timed) events per crank rotation	2	3
Number of Jobs Stored in Memory	100	100
Memory Chips Removable (sockets)	Yes	Yes
Brake and Die Sensor Inputs optically coupled AC or DC (sourcing or sinking)	Yes	Yes
Length of Name of Job (characters)	7	13
Motion Detection Lack of (Motion Fault) Unintended (Drift Fault)	Yes	Yes
Brake Monitoring (Time-Based)	Yes	Yes
SPM Indicator (strokes per minute)	Yes	Yes
Servo Feed Interface	Yes	Yes
Counters: Stroke, Batch, Quality, and Part	Yes	Yes
Password and/or Supervisory Controlled Selector Switch	Yes	Yes
PCLink to allow off-line job storage and creation	Yes	Yes
Speed Compensation of User Selected Outputs	Yes	Yes
Tonnage monitoring	N/A	Optional
Resolver & Cable Supplied	Yes	Yes
Built-in 90° and 270° stop time tester	Yes	Yes



PressCam 8
Junior



PressCam 8

For OSHA and ANSI Compliant Clutch/Brake Press Controls, please see the PressCommander.

Punch Press Automation

PressCam 8 Junior Layout



Design Features

- All six Limit Switch Outputs can be set to cycle (non-timed) two times per crank rotation by setting an open / close crank angle.
- The last three outputs can be set for timed, non-timed, delayed, and hold or cycled two times per crank revolution.
- Major faults such as E-Stop, motion, brake, and sensor faults are handled by two force-guided relays (Form B Safety relays).
- The six outputs are small, high-speed, high-capacity relays.
- Brake and die sensor inputs are optically coupled and can be either AC or DC (sourcing or sinking).
- Up to 100 Jobs can be saved using a nonvolatile memory chip. The memory chip is removable for ease of transfer. Each Job Number stores a name and/or number up to 7 characters for easy identification.
- Built-in Brake Monitor will issue a warning when the programmed warning time is exceeded and will issue a failure signal when programmed stop time is exceeded.
- True Motion Detection system checks for lack of motion (Motion Fault) and unintended motion (Drift Fault).
- SPM Indicator (Strokes per Minute).
- Crank angle shown graphically and in large numbers.
- Speed compensation of user selected outputs.
- Servo feed interface.
- Stroke, Batch, Quality, and Part Counters to keep track of operation.
- Password and/or Supervisory Controlled Selector Switch to prevent altering of parameters, except for the counters.
- PCLink to allow offline job creation and storage.
- Built-in 90° and 270° stop time tester.

Punch Press Automation

PressCam 8 Junior

Overview



The PressCam 8 Junior is a resolver-based press automation controller that incorporates a programmable cam limit switch, timed-based brake monitor, servo feed control, four counters, and a die protection system. The PressCam 8 Junior is controlled by a 16-bit computer that constantly checks the resolver for accuracy.

The PressCam 8 Junior has a keypad, menu, cursor buttons (for easy navigation and operation), and a four line (20 characters each line) vacuum fluorescent display for easy viewing purposes.

A “RUN/PROG” keyswitch is also provided where, while in the “RUN” mode, you are not able to alter any parameter or job change. The “RUN” mode only allows the user to clear counters and reset die sensor faults. In the PROG mode, the Die Faults do not open up the fault relays which allows for die setups. All other faults will cause the fault relays to open. If the password feature is enabled, you must first enter in the three digit password in order to pass into the PROG mode to allow parameter changes.

Industrial Grade Brushless Resolver Transducer



The heavy duty brushless resolver transducer replaces the current mechanical rotary cam switch. This unit was designed for hostile industrial environments such as punch press mechanical shock and vibration, extreme temperature and humidity, oil, coolant, and lubrication mists. The resolver transducer features excellent repeatability and gives absolute shaft position feedback. High speed operation along with long transducer cable (runs up to 600 feet/183m) give the resolver transducer wide application ranges. The resolver transducer is a passive device which contains no sensitive electronics and has superb noise immunity.

The resolver mounts easily to an end of a crankshaft and can rotate clockwise or counter-clockwise. Simple connector ended transducer cabling is supplied to connect the resolver to the PressCam 8 Junior controller console. The PressCam 8 Junior’s microprocessor-based control constantly monitors the resolver position and displays both the angular position of the shaft and speed of the machine (tachometer). 3/4” (19 mm) resolver shaft diameter.

Punch Press Automation

PressCam 8 Junior

Specifications

Input Power: 3 Voltage Ranges:

24VDC (optional)
120VAC (standard)
240VAC (optional, jumper selectable)
All AC voltages work with 50 or 60 Hz
10 watts with all relays on

Fuses:

<i>I/O Board:</i>	F1 to F8	LS Outputs	5A Fast Blow (20-023)
	F7	Power	1A Slow Blow (20-022)
	F9 to F15	Die Inputs	5A Fast Blow (20-023)
	F35	12VDC	5A Fast Blow (20-023)
<i>Computer:</i>	F1	Power	5A Fast Blow (20-023)

Indicators:

Computer: Vacuum Fluorescent 4 lines/20 characters
-5V (GRN) D10

I/O Board:

8 Optically coupled inputs (RED):
Power ON D22
Brake D21
Die 1-6 D15-D20
6 LS Outputs (GRN)
LS1-6 D1-D6

Set Points:

Stroke Count:	0 to 999,999	strokes
Batch Count:	0 to 999,999	strokes
Quality Count:	0 to 999,999	parts
Part Count:	0 to 4	parts/stroke
	0 to 999,999	parts total
Batch Size:	0 to 999,999	strokes
Limit switch angle:	0 to 359	degrees
Limit switch timer:	0 to 9999	milliseconds
Die sensor angle:	0 to 359	degrees
Speed Compensation	0 to 99	degrees
Minimum Speed:	0 to 999	SPM
Maximum Speed:	0 to 999	SPM
Brake Warning:	1 to 999	milliseconds
Brake Failure:	1 to 999	milliseconds
Brake Actual:	1 to 999	milliseconds (+/- 1 millisecond accuracy)
Motion:	0 to 5.9	seconds (1/10-sec increments)
Drift:	preset to 2	SPM (1/10 SPM increments)
Crank Angle:	0 to 359	degrees (1-degree increments)
SPM:	0 to 999	strokes/minute (+/- 1 SPM accuracy)

Construction

Stand Alone Unit:

All 18 gauge painted steel NEMA 12 lockable box with sealed front panel
Dimensions:
7 1/4" (184mm) width; 9" (229mm) height; 3 1/4" (83mm) depth

Panel Mount Unit:

All 18 gauge painted steel NEMA 12 with gasket around edge.
Dimensions: 6 1/2" (165mm) width; 7 1/8" (181mm) height

Temperature Range

0 to 50°C

Resolver

+/- 1° Resolution up to 600 RPM (+/- 2° Resolution from 601 to 1000 RPM)
Shaft loading: Radial 400 lbs., Axial 200 lbs. - 3/4" (19mm) diameter shaft
Standard cable 30' (9m). Maximum length of 600' (183m).

Punch Press Automation

PressCam 8 Junior

Main Screen

The Main Screen allows for Job Selection and Naming, Parts, and Batch Count.

```
Job: 00

Parts: 000000
Batches: 000000
Angle: 000 SPM: 000
```

Brake Monitor

In RUN Mode, the screen displays the Last Stop Time (in mSEC) and Last Dwell angle (in degrees).

```
Last Stop Time= 000
Last Stop Time= 000
```

In PROG mode, the original screen is displayed but with the Dwell angle added to the bottom line of the screen.

```
Warn= 000 Fail= 000
Motion Det= 0.0 sec
90° - 270° test
Dwell= Time= 000
```

Counter

The PressCam 8 Junior provides four types of counters: Stroke, Batch, Quality, and Part. When programmed, a counter will increment each time a part is ejected from the machine. When the programmed value is met, the controller will initiate an action.

```
Strokes: 000000
Parts: 000000 /1
Batch size: 000000
Quality: 000000
```

Servo Feed

Each PressCam 8 Junior job stores individual Servo Setup information and outputs through the RS-232 every time the unit is powered up, after you exit from the Servo Setup screen and after a job change. The Servo Setup screen can be accessed only while in PROG mode.

```
Speed 1-100: 000
Accel 1-100: 000
MPC 1-100: 000
Feed Len.: 000.000
```

Press Utility

This screen allows you to program the following settings: speed compensations, minimum speed, maximum speed, clear job, top dead center, PC link, and set password.

```
Speed comp: 000
Min= 000 Max= 000
ClrJob SetTDC
PCLink Password 000
```

Limit Switches

The following screen monitors the status of all six relay outputs as well as displays the current crank angle.

```
LS1 LS4
LS2 LS5
LS3 LS6
ANGLE: 000 MONITOR
```

Cyclical Outputs

```
S CLS-OPN CLS-OPN
LS1 000-000 000-000
LS2 000-000 000-000
LS3 000-000 000-000
```

```
S CLS-OPN CLS-OPN
LS4 000-000 000-000
LS5 000-000 000-000
LS6 000-000 000-000
```

Cycle Delay & Hold Outputs

	DLY CY	HLD CY
LS4	000	000
LS5	000	000
LS6	000	000

Timed Outputs

	STRT ANG	HLDmSEC
LS4	000	0000
LS5	000	0000
LS6	000	0000

Die Input

A unique name can be created for six die sensors (SEN1-SEN6) in the PROG mode while viewing the die monitor screens.

	TYPE	BGN END
SEN1	MOM	000-000
SEN2	MOM	000-000
SEN3	MOM	000-000

	TYPE	BGN END
SEN4	MOM	000-000
SEN5	MOM	000-000
SEN6	MOM	000-000

The Die Status Screen allows you to run the press and see when die sensors activate relative to press angle.

SEN1	*	SEN4
SEN2		SEN5 *
SEN3	*	SEN6
ANGLE: 000		MONITOR

Punch Press Automation

PressCam 8 Junior Overview/Ordering Procedure



The PressCam 8 Junior is a resolver-based press automation controller that incorporates a programmable cam limit switch, timed-based brake monitor, servo feed control, four counters, and a die protection system. The PressCam 8 Junior is controlled by a 16-bit computer that constantly checks the resolver for accuracy.



PressCam 8 Junior (all styles, Front panel & Stand alone). Includes resolver and cable

ORDERING PROCEDURE

1. Specify Mounting Style
 - F Front Panel Mounting to be installed in an existing control panel.
 - C Stand alone NEMA12 enclosure
2. Specify Controller input power
 - 1 24VDC
 - 2 120VAC 50-60Hz
 - 3 240VAC 50-60Hz
3. Specify Clutch/Brake Valve Voltage
 - 1 24VDC
 - 2 120VAC 50-60Hz
4. Resolver Connector Cabling
 - 30' (9m) of cable with connectors is supplied standard. If additional length is needed, specify in feet, 150' (46m) maximum.

EXAMPLE PART NUMBER

JR
-
C
-
2
-
1
-
30'

Mounting Style
Input Power
Clutch/Brake Valve Voltage
Resolver Cable

(For Custom Programming & Remote Field Upgrades, please consult factory at service@pressroomelectronics.com or (630) 443-9320.)

Part Number	Description
30-012	24vdc @ 2.2A power supply (90-260vac In) 3.9" L x 3.8" W x 1.4" H (99.1mm x 96.5mm x 35.6mm) for powering die protection sensors or other auxiliary devices

Punch Press Automation

PressCam 8 Junior

REPLACEMENT PARTS LISTING

Part Number	Description
11-157	Panel Mount (with gasket)
11-158	Metal Box enclosure (with gasket)
11-160	Aluminum Shield cover for computer board
18-008	Vacuum fluorescent display (must be factory installed)
20-022	1A Slo-Blo nano SMF fuse
20-023	5A Fuse (white nano)
26-084	Graphic overlay skin
32-002	Output Relay (black G6B-1174P)
32-006	Output Relay (black G6B-2114P)
32-101	4 pole 12 VDC (clear KACO safety relay)
35-065	EEPROM Job memory chip (100 jobs)
39-084	RUN/PROG keyswitch, key, and cable
45-020	Resolver cable (30') with connectors
52-205	Junior computer board (with job memory)
52-206	Junior Power supply / Relay output board (with relays and fuses)
52-227	Resolver unit (no cable) (formerly 40-003)

Punch Press Automation

PressCam 8 Junior

Dimensions

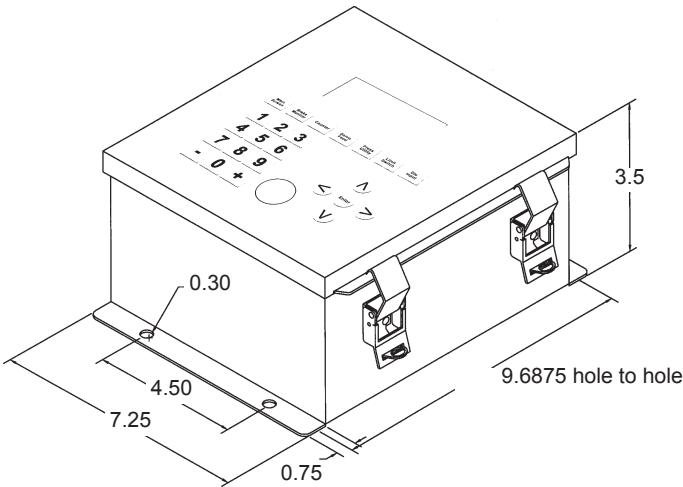

PressCam 8 Junior shown installed in a stand alone NEMA 12 (IP64) lockable enclosure

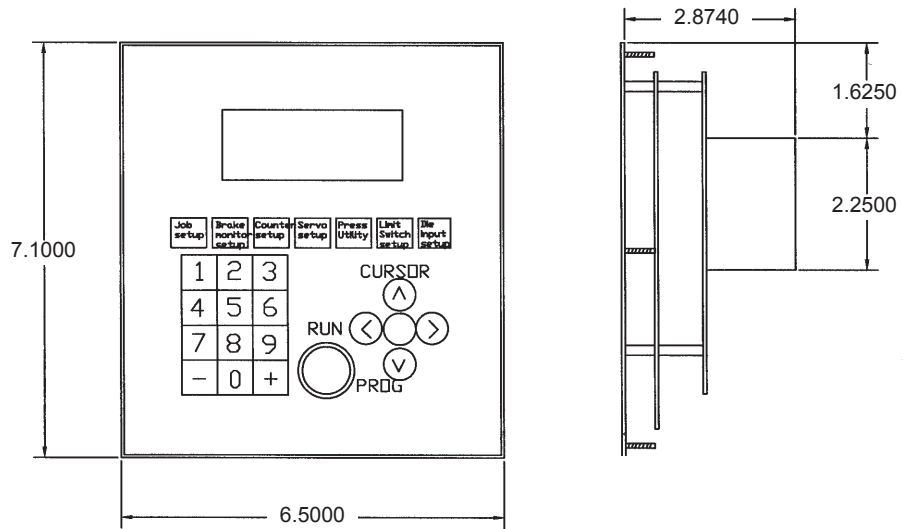

PressCam 8 Junior Front Panel Mount Cut-Out Dimensions

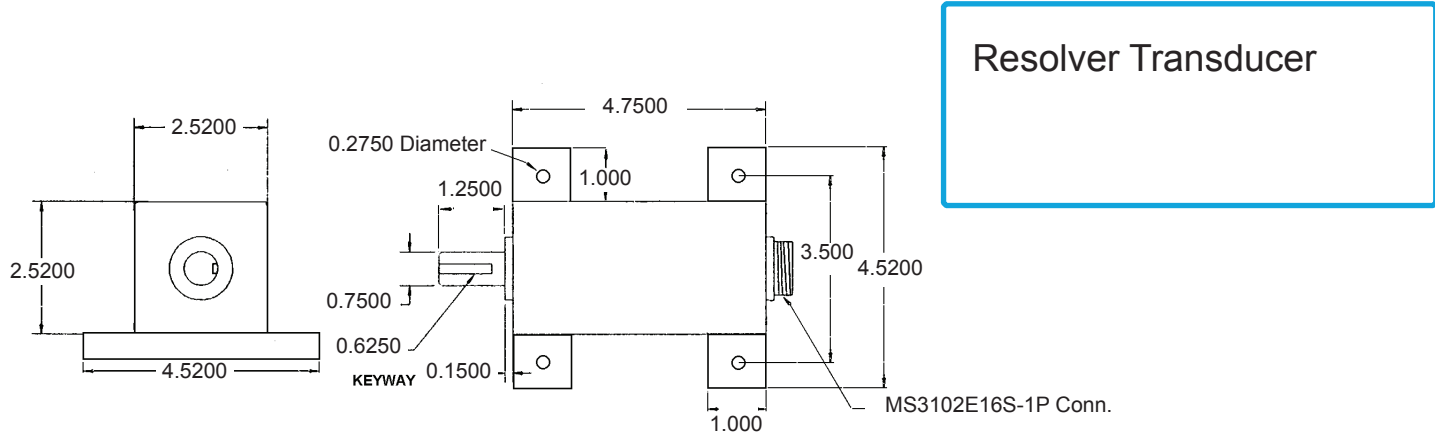

Resolver Transducer

Punch Press Automation

PressCam 8

Design Features

- “Control Reliable” design, utilizing two 16-bit computers, provides ultimate pressroom safety in automation.
- Operator “full view” of system status means no getting lost during programming.
- PressCam 8’s two 16-bit computers are configured to cross check each other and the resolver.
- All safety function faults utilize three monitored captive contact safety relays for the outputs related to motion detection, brake monitoring, and system self-checking (Form B safety).
- Non-volatile job memory of 100 stored programs recalled by job die number for all system functions.
- Eleven programmable limit switch outputs with multiple ON/OFFs per press cycle.
- Outputs can be solid state (AC or DC) or mechanical relays.
- Supervisory controlled RUN/PROG keyswitch with password protection.
- Built-in time-based brake monitor can issue warnings or a stop command when actual stopping time exceeds programmed set points.
- Built-in motion detection fault output should the press not start moving within the timed set point after the brake signal is given.
- Built-in drift detection fault output if the press moves when it should not.
- Built-in 90° and 270° stop time tester.
- PressCam 8’s cloning feature allows multiple PressCam 8 units to link via RS-232 for job copying.
- Contrast adjustment of the LCD computer screen.
- Automatic offset programming.
- Built-in press tachometer (SPM).
- Optically isolated AC and/or DC inputs (sourcing or sinking).
- Parts counter which can be programmed from 1 - 4 parts per press cycle for multiple out dies.
- Large 8” (203mm) diagonal computer screen (LCD).
- Unique digital programming knob acts like a PC mouse and eliminates keypad programming.
- The “control reliable” PressCam 8 can be used to supply the timing signals for the clutch/brake press control.
- Complete system diagnostics with plain English fault messages on the operator screen enhances productivity.
- PressCam 8 programs can be field upgraded or customized using a PC computer with a standard serial port.
- Four programmable timed limit switch outputs that can be position based or timed from 0 to 9999 milliseconds.
- Four Counters: Strokes, Parts, Batch, and Quality.
- Built-in power supply for input sensors (+12VDC).
- Built-in servo feed interface.
- Crank shaft angle displayed in degrees with a graphic shaft angle clock.
- Utilizes surface mount technology.
- Job memory chips are socketed for easy transfer to other units if desired.
- Programmable minimum and maximum speed limits with captive contact safety relay output (Form B safety).
- Programmable variable speed compensation.
- Punch press clutch/brake timing signals protected from tampering.
- Optional peak tonnage monitoring up to 4 channels.
- Compact in size.





Punch Press Automation

PressCam 8

Overview

PressCam 8 is a “control reliable” resolver-based programmable cam switch, time-based brake monitor, die protection system with multiple counters and much more in one package. The system contains two 16-bit computers that are configured to cross check each other and the resolver. The dual computers are interfaced with a full view 8" (203mm) diagonal LCD computer screen for viewing and programming ease. This large operator screen (shown on the next page) supplies operators and front line supervisors production data without the need of cumbersome menu and program access codes.

All system faults generate descriptive plain English error messages on the computer screen. This provides floor personnel fast and reliable information related to the machine stoppage. The system is also provided with special watchdogs that turn off fault outputs should either computer become erratic. The software and system customization in both computers can be upgraded in the field using a PC computer with a standard serial port.

Programming PressCam 8 is so easy that you do not need a keypad, keyboard, or cumbersome programming techniques.

Operator Screen

A large 8" (203mm) diagonal LCD computer screen is standard equipment on the PressCam 8. This single component brings the intelligence of the dual computer system to the punch press control panel providing positive system status interaction with the machine operator.

The screen brightness (contrast) is also adjustable so it can be easily read even when installed in dark areas.

Digital Programming Knob

This innovative device replaces keypads or keyboards for programming the PressCam 8. The programming knob works similar to a computer mouse. Simply turn the knob to the highlighted field or program you desire then push. Your program is accessed with no keystrokes. By turning the knob, the appropriate numbers or letters appear on the highlighted screen to program the specific function you desire. Push again, your programming is completed! Additionally, no information can be programmed if it is not applicable to the specific function or operation.



Industrial Grade Brushless Resolver Transducer

The heavy duty brushless resolver transducer replaces the current mechanical rotary cam switch. This unit was designed for hostile industrial environments such as punch press mechanical shock and vibration, extreme temperature and humidity, oil, coolant and lubrication mists. The resolver transducer features excellent repeatability and gives absolute shaft position feedback. High speed operation along with long transducer cable (runs up to 600 feet/183m) give the resolver wide application ranges. The resolver is a passive device which contains no sensitive electronics and has superb noise immunity.

The resolver mounts easily to an end of a crankshaft and can rotate clockwise or counter-clockwise. Simple connector ended transducer cabling is supplied to connect the resolver to the PressCam 8 controller console. The PressCam's microprocessor-based control constantly monitors the resolver position and displays both the angular position of the shaft and speed of the machine (tachometer). 3/4" (19 mm) resolver shaft diameter.

Punch Press Automation

PressCam 8

Programming Screen

JOB # 65		DIE No. 536		LS/OUTPUTS		DIE SENSORS	
Stroke Count	19	Batch Count	0	Quality Count	300	Part 4 Count	612
Batch Size	190	Reset All Faults		Adjust Contrast		Running Time	
Die Sensor Setup		Limit Switch Setup		Servo Setup		Tonnage Setup	
Press Utility		Speed Comp.	20°	Minimum Speed	4 SPM	Maximum Speed	129 SPM

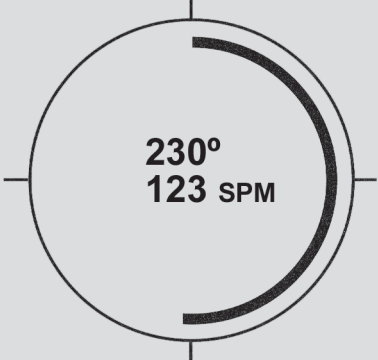

230°
123 SPM

1		ok	1	*	staticNO
2		ok	2		staticNO
3		ok	3		momen.
4			4		FAULT
5			5		
6			6		
7			7		
8			8		
9			9		
10			10		
11			11		
12		COUNTER	12		
13	*	DIE FLT	13		
14	*	SPEED	14		
15	*	GF1	15		
16	*	GF2	16		

BRAKE MONITOR SETPOINTS				
WARN	FAIL	ACTUAL	MOTION	90° Stop Test
50msec	100msec	0msec	0.5sec	



Screen Actual Size

Shown above is the actual screen size and information available to the press operator on the PressCam 8 Programming Screen. No longer is it necessary to scroll through various menus and programming techniques to view data. The Programming Screen also provides an active “tool bar” for your press set-up personnel to quickly access the specific function they so desire. As one can see, a tremendous amount of production data can be obtained by simply viewing this single operator screen.

System simplicity is a dominant feature of the PressCam 8. By viewing the above screen, information can be obtained for four different counters, reset all faults, adjustment for screen contrast, die protection information, programmable limit switch information, shaft angle displayed in degrees, stroke per minute (SPM), and brake monitoring information.

Additionally, system fault messages are displayed in the area above the brake monitor setpoint section when they occur.

Punch Press Automation

PressCam 8

Die Protection

Sensor			Event Window		Sensor			Event Window	
Name	Type	on	Begin	End	Name	Type	on	Begin	End
Sen 1	N.C.	*			Sen 9				
Sen 2	N.O.				Sen 10	Moment	*	20°	301°
Sen 3	Moment		100°	150°	Sen 11				
Sen 4	Maintain N.O.				Sen 12				
Sen 5	Maintain N.C.				Sen 13				
Sen 6					Sen 14				
Sen 7					Sen 15				
Sen 8					Sen 16				

EXIT (return back to main screen)									
-----------------------------------	--	--	--	--	--	--	--	--	--

The diagram shows a circular crank angle scale from 0° to 360°. A shaded arc is drawn from 100° to 150°, labeled '100° Begin' and '150° END'. Below the scale, it says '50° Dwell'. To the right of the diagram, the text reads 'Crank Angle 300°' and 'DIE SENSOR SETUP PRESSCAM 8'. The PressRoom Electronics logo is in the bottom right corner.

Screen Actual Size

The Die Protection Screen shown above is what your programmer will see when entering the die protection program. PressCam 8 provides sixteen different die protection sensor inputs that may be programmed for both cyclic and/or static function monitoring.

Cyclic function monitoring requires that an input sensor signal occur within a certain programmed shaft angle on each press cycle (e.g., part eject, part transfer).

Static monitoring is used for non-cyclic events such as end of material or stock buckle monitoring.

A fault output will occur if an input transition is not detected between the programmed limit set points (e.g., a part is to be ejected out of the die between 190° and 250° of the machine cycle). If the part is not detected within these parameters, a fault or stop signal is given to stop the machine.

To program, simply turn to “die-sensor set-up” and depress the programming knob. Now you are in the die protection program. Then put in the parameters in degrees when you would want to look for the part to eject or transfer. From 190° to 250° is when the sensor will be looking for the part. That is all there is to programming die protection. If a fault output occurs, simply view the screen and determine from what sensor the fault occurred.

The die protection program can be fine tuned while the machine is in motion along with related peripheral signals such as feeds, lubrication, blowoffs, etc. This is an excellent method of increasing the machines efficiency.

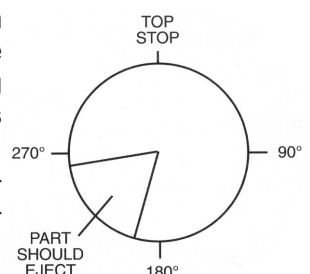

Punch Press Automation

PressCam 8

Programmable Limit Switch

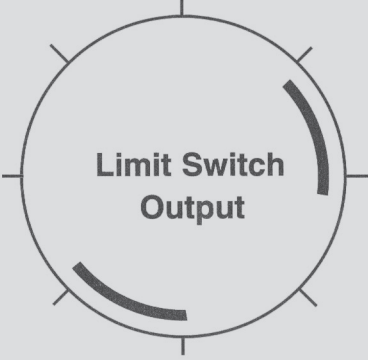
Output	sp	First		Second		Third		Crank Angle 300°	
		Close	Open	Close	Open	Close	Open		
LS1	*	300°	320°						
LS2	*	200°	150°						
LS3		50°	100°	180°	230°				
LS4									
LS5									
LS6									
LS7									
						Delay Cycle	Hold Cycle	Start Angle	Hold Time
LS8									
LS9								100°	1000
LS10									
LS11									
EXIT	LIMIT SWITCH OUTPUT SETUP SCREEN								



Screen Actual Size

Limit switch programming simplicity is a PressCam 8 feature.

PressCam 8 crank angle position is generated by a heavy duty industrial resolver driven by the press crank shaft.

PressCam 8 provides the user with eleven programmable limit switch outputs used to initiate various peripheral equipment. These outputs can be programmed to turn on and off up to three times per press cycle.

The programmable limit switch outputs may be mechanical relay, solid state AC, or solid state DC. The solid state relays may be mixed on the same relay board.

The Delay and Hold cycle feature provides control for lubrication systems, scrap choppers, etc. This provides you with signals when you need events to occur on a pre-programmed intermittent (time) or multiple stroke basis.

Limit switches 1 – 7 can be programmed to turn ON and OFF up to three times per press cycle. Limit switches 8 – 11 can be programmed to turn ON and OFF up to two

times per press cycle or may be programmed to turn ON based on angle and OFF based on time. The timed outputs can be programmed from .001 to 10 seconds. Furthermore, these switches may be used with the Delay and Hold cycle feature which provides control for items that need not be initiated on every press cycle but a programmed number of press cycles. Or they can be held ON for a pre-programmed number of press cycles.

A minimum and maximum speed limit setting can be used to monitor optimum running speed versus actual. A deviation outside the programmed parameters will initiate a stop signal.

The system includes a true motion detection system that monitors the press cycle. If you tell the press cycle and it fails to move within the pre-programmed time (.001 to 4 seconds), a fault signal is issued. On the opposite side, if the press starts to cycle without initiation, a fault signal is issued to electrically disconnect all signals.

The clutch/brake timing signals can also be password-protected from inadvertent tampering by unauthorized personnel.

Punch Press Automation

PressCam 8

Tonnage Screen

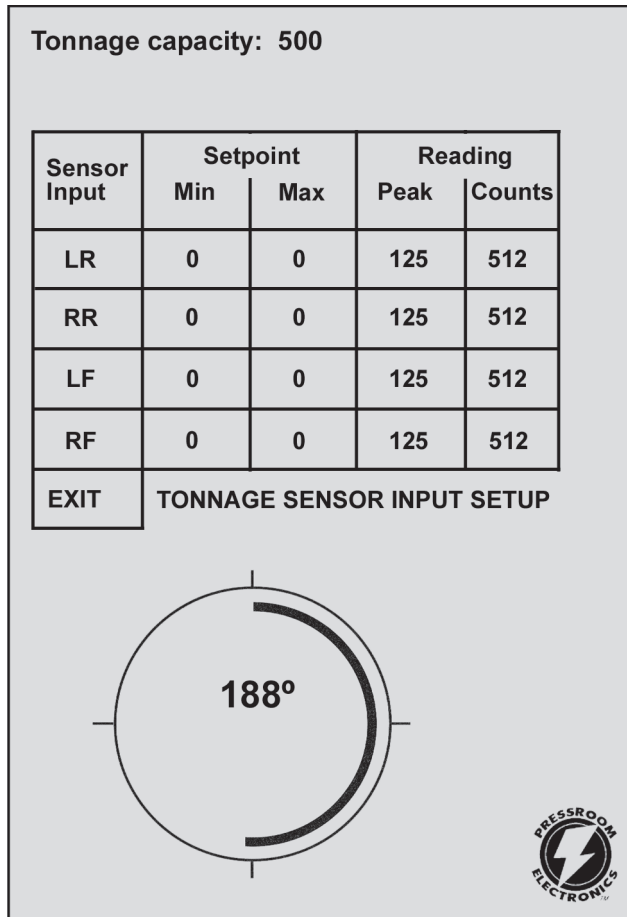

The TLM I/O load module is designed for critical force measurement applications where accuracy, extreme stability, and dependable noise rejection is essential. The module is a load measurement device without a display or alarms. The TLM is used as an input device to the PressCam 8 providing display and alarm control functions.

The TLM has high sensitivity levels that work well in an electrically “noisy” environment. It has two amplifier gain ranges (span ranges). Therefore, it can accept either weak or strong signals from the load sensor.

Features

- Signal conditioning module for strain gauge sensors and load cells
- Four independent channels for accommodating up to eight sensors
- For use with full-bridge sensors from 120 Ohms to 1,000 Ohms
- Plug-in connectors are used for the sensor inputs
- High/low sensitivity span ranges selected with front panel switch
- Automatic zero balance circuits assure accurate measurements
- Power input/output are plug-in connectors
- Built-in automatic peak load memory circuits
- Peak measurements are made with an external trigger device
- Built-in power supply for stable operation and noise rejection
- Compact size to fit almost any location
- Steel enclosure for maximum protection and noise rejection

Specifications

Transducers Full Bridge, 120 Ohms to 1,000 Ohms. One to four channel version available. Maximum of two 350 Ohms sensors per channel.

Dimensions 2" (51mm) x 3.1" (79mm) x 8.95" (227mm)

Balance Range +/- 1 mV/V of offset

Gain - Two Ranges Low = 100 to 1,100 adjustable
High = 1,000 to 11,000 adjustable

Output Range Approximately +/- 10VDC at 12VDC excitation

Circuit Accuracy Maximum inaccuracy of +/- 1% of full scale

Circuit Linearity Maximum non-linearity +/- .1% of full scale

Auto Zero Time Constant 10 seconds

Frequency Response Flat DC to 1 KHz

Peak Decay Less than 1% of full scale in 10 minutes

Calibration Shunts 1 Meg Ohm, .1%

Input Power 100 to 130VAC 50-60 Hz. Fused at .10 Amp.
200 to 260VAC 50-60 Hz. Fused at .05 Amp.
Input is jumper selectable. Fuses are 5mm x 20mm SLO-BLO.

Sensor Excitation Internally excited at +12VDC, .30 Amps maximum

Sensor Input Connections Four pin .2" (5mm) centers Phoenix connector

Peak Output Connections Six pin .2" (5mm) centers Phoenix connector

Proximity Probe 12VDC internally supplied to drive NPN or PNP probes, 50mA max. Input also supports dry relay contacts.

Punch Press Automation

PressCam 8

Specifications

Input Power:	3 Voltage Ranges: 1) 24VDC (optional) 2) 120VAC (standard) 50 or 60 Hz 3) 240VAC (optional) 50 or 60 Hz	24 watts with all relays
Input Control Unit:	Monochrome LCD 8" (203mm) Diagonal Display	
Display	<ul style="list-style-type: none"> • LCD BIAS (GRN) D16 • Vpp (YEL) D8 • 5VDC (GRN) D14 	
I/O Board:	+12 VDC (RED) D2 17 Optically Coupled Inputs 13 Solid-State or Mechanical Relay Outputs 3 Force-Guided Monitored Safety Relay Outputs (Form B)	
Relays:	Mechanical - SPDT Form C 10 AMP @ 260VAC 10 AMP @ 30VDC Mechanical Captive Contact - Form B 8 AMPS @250VAC	AC Solid State - SP N.O. 3 AMP @ 140VAC 12-14VAC 25-70 Hz DC Solid State - SP N.O. 3 AMP @ 60VDC 12-60 VDC
Set Points:	Stroke Count: 0 to 999,999 strokes Batch Count: 0 to 999,999 strokes Quality Count: 0 to 999,999 parts Part Count: 1 to 4 parts/strokes (programmable) 0 to 999,999 parts total Batch Size: 0 to 999,999 parts Limit Switch Angle: 0 to 359 degrees Limit Switch Timers: 0 to 9999 milliseconds Die Sensor Angle: 0 to 359 degrees Minimum Speed: 0 to 300 SPM Maximum Speed: 0 to 300 SPM Brake Warning: 1 to 999 milliseconds Brake Failure: 1 to 999 milliseconds Brake Actual: 1 to 999 milliseconds (+/- 1 ms accuracy) Start Motion: 0 to 5.9 seconds (1/10 sec increments) Crank Angle: 0 to 359 degrees (1 degree increments) SPM: 0 to 300 strokes/minute (+/- 1 SPM accuracy)	
Components:	<ul style="list-style-type: none"> • PressCam 8 Master Controller Panel Mount 10.8" (274mm) W x 11.8" (300mm) H x 2.5" (64mm) D • PressCam 8 Master Controller mounted in a Stand Alone NEMA 12 Enclosure 11" (279mm) W x 13.1" (333mm) H x 5" (127mm) D • Resolver Transducer +/- 1° Resolution up to 700 RPM +/- 2° Resolution from 701-1000 RPM 3/4" (19mm) keyed shaft <i>Rated shaft loading:</i> 200 lbs. axial 400 lbs. radial <i>Weight:</i> 4 lbs. <i>Vibration:</i> 20g to 2000 Hz <i>Enclosure:</i> NEMA 13 <i>Rotation:</i> CW or CCW 	
Diagnostics:	Complete system diagnostics on LCD screen	
Enclosure Construction:	18 gauge painted steel NEMA 12 lockable enclosure with sealed front panel or open frame for panel mounting.	
		<i>Shock:</i> 200 G for 11 msec <i>Operating Temp:</i> -20° to 125°C <i>Transducer to master controller:</i> 600' (183m) max <i>Resolver Cable:</i> 30' (9m) supplied standard with connectors



Punch Press Automation

PressCam 8 Overview/Ordering Procedure

PressCam 8 is a "control reliable" resolver based programmable cam switch, time-based brake monitor, die protection system, multiple counters, and much more in one package. The system contains two 16-bit computers that are configured to cross check each other and the resolver. The dual computers are interfaced with a full view 8" (203mm) diagonal LCD computer screen for viewing and programming ease. This large operator screen supplies operators and front line supervisors production data without the need of cumbersome menu and program access codes.

(For Custom Programming & Remote Field Upgrades, please consult factory at service@pressroomelectronics.com or (630) 443-9320.)

PressCam 8 (all styles, Front panel & Stand alone). Includes resolver and cable

ORDERING PROCEDURE

1. Specify Mounting Style
 - F Front Panel Mounting to be installed in an existing control panel.
 - C Stand alone NEMA12 enclosure
 - T Stand alone NEMA12 enclosure with room for the Tonnage Module
2. Specify Output Relays (11 maximum)
 - M Mechanical Dry contact relays SPDT 10A@250VAC
 - A AC Solid State - single Pole N.O. 3A@140VAC, 12-140VAC, 25-70Hz
 - D DC Solid State - single Pole N.O. 3A@60VDC, 12-60VDC
3. Specify Controller Input power
 - 1 24VDC
 - 2 120VAC 50-60Hz
 - 3 240VAC 50-60Hz
4. Specify Clutch/Brake Valve Voltage
 - 1 24VDC
 - 2 120VAC 50-60Hz
5. Resolver Connector Cabling

30' (9m) of cable with connectors is supplied standard. If additional length is needed, specify in feet, 150' (46m) maximum.
6. Specify Tonnage Monitoring (optional)
 - T1 One Channel monitoring with strain sensor and cable
 - T2 Two Channel monitoring with strain sensor and cable
 - T3 Three Channel monitoring with strain sensor and cable
 - T4 Four Channel monitoring with strain sensor and cable

EXAMPLE PART

PC8 - **C** - **Mechanical** - **AC Solid State** - **DC Solid State** - **1** - **1** - **30'** - **T4**
 Style Mounting Style Output Relays Output Relays Output Relays Input Power Clutch/Brake Valve Voltage Resolver Tonnage

TONNAGE MONITORING (OPTIONAL)

- T1** One channel monitor module with strain sensor and cable
- T2** Two channel monitor module with strain sensor and cable
- T3** Three channel monitor module with strain sensor and cable
- T4** Four channel monitor module with strain sensor and cable

Part Number

Description

30-012 24vdc @ 2.2A power supply (90-260vac In) 3.9" L x 3.8" W x 1.4" H (99.1mm x 96.5mm x 35.6mm) for powering die protection sensors or other auxiliary devices.

Punch Press Automation

PressCam 8

REPLACEMENT PARTS LISTING

Part Number	Description
11-131	Panel Mount (with gasket)
11-132	LCD mounting bracket (blue)
11-133	Aluminum Shield cover for computer board
11-134	Metal Box enclosure (with gasket)
11-135	Solid State Relay hold-down for I/O board
11-159	Large Metal Box enclosure (includes space for TTLM module)
18-005	B/W LCD display panel (with backlight)
18-006	LCD Backlight power supply
18-007	LCD Backlight fluorescent tube
20-022	1A Slo-Blo nano SMF fuse
20-023	5A Fuse (white nano)
21-047	Tuning Knob (black knob)
21-048	Tuning Knob (black ring)
26-071	Graphic overlay skin
30-009	Replacement Tonnage Controller (3 or 4 channel input unit)
30-010	Replacement Tonnage Sensors & 35' of cable
30-013	Replacement Tonnage Controller (1 or 2 channel input unit)
32-038	Output Module (Solid State AC)
32-039	Output Module (Solid State DC)
32-041	Output Relay (G2R-1-S)
32-101	4 pole 12 VDC (clear KACO safety relay)
35-065	EEPROM JOB memory chip (50 jobs) (2 chips are required for 100 jobs) (2 chips are required for 100 jobs)
39-051	RUN/PROG Keyswitch (with keys and cable)
40-002	Tuning Encoder device
45-019	LCD cable (from LCD to Computer board)
45-020	Resolver cable (30') with connectors
52-115	Power & I/O board (without output modules) specify solid-state or relay
52-116	Dual Computer board (with 100 job memory)
52-122	I/O ribbon cable (from I/O board to Computer board) 2'
52-123	Power cable (from I/O board to Computer board) 2'
52-227	Resolver unit (no cable) (formerly 40-003)
52-282	Serial to Ethernet Board for PressCam 8

Punch Press Automation PressCam 8

Dimensions

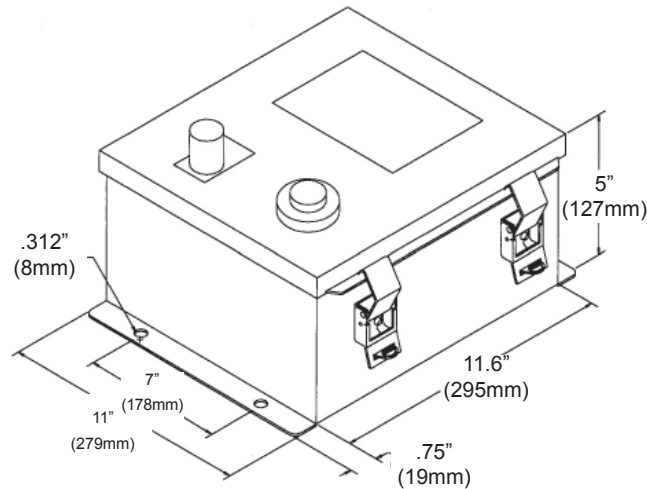

PressCam 8 shown installed in a stand alone NEMA 12 (IP64) lockable enclosure
 Dimensions for the Tonnage version of the PressCam 8 are 14.5" (368mm) W x 13.1" (333mm) H

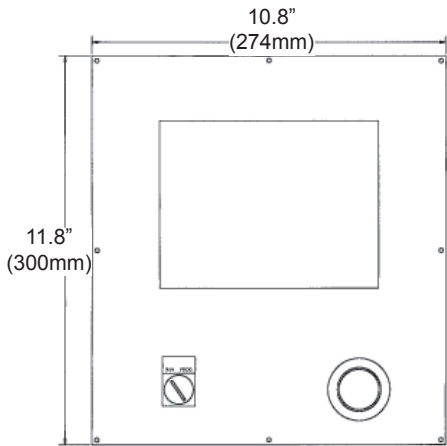

PressCam 8
 Front Panel Mount

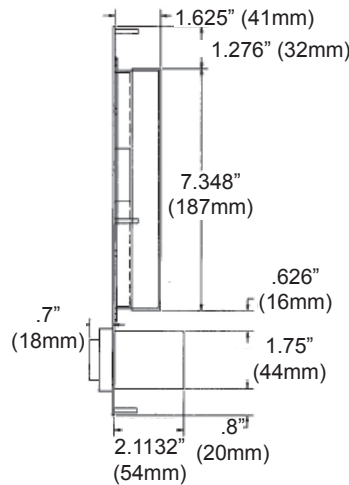

Resolver Transducer

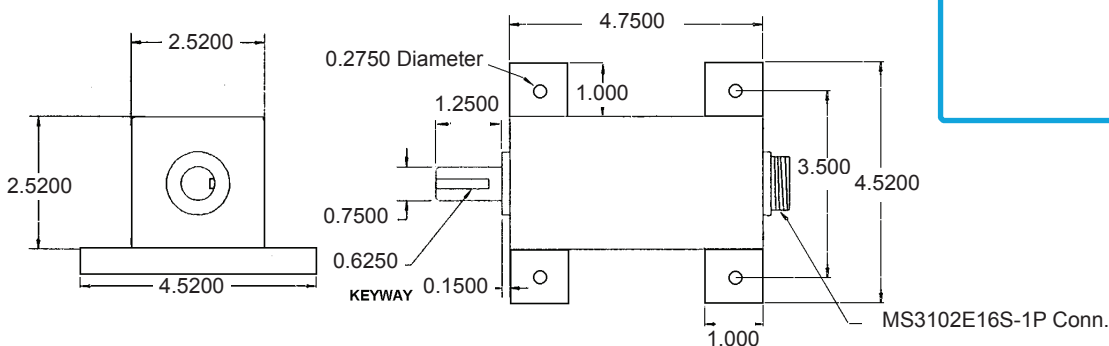

Model FPC Control System

Open Architecture Multi-function Machine Controls for Fluid Power Safety of Hydraulic or Pneumatic Energy Based Machines

Design Criteria

- Complies with OSHA and ANSI Codes B11.3-2012 and B11.2-2013 requirements.
- Complies with ANSI (American National Standards Institute) various B11 standards.
- Control reliable design for rotary (resolver or rotary cam) or linear action machines.
- Category 4 Control Category per EN 954.
- Performance Level – PL e per EN/ISO 13849-1.
- The FPC Control has redundant cross-checking microprocessors.
- The FPC Control has redundant DC power supplies.
- The FPC Control has redundant and monitored ram advance with force guided output relays and external relay monitoring.
- The FPC Control monitors faults, including diminished performance faults. The control's fault detection has no dependency on external machine controls.
- The FPC Control returns the machine to a safe position whenever there is loss of pressure or other such event.
- The FPC Control stops the machine operation upon detection of a fault condition until such condition is corrected.
- The FPC Control contains a dedicated specific reset input which prohibits a machine reset by removing or re-applying the pneumatic or hydraulic power.
- The FPC Control requires that the machine reset(s) be operator actuated.
- The advanced platform engineering of the FPC control provides the end user field functionality upgrades or program modifications via an on board USB port for downloads. Ethernet is optional.

Applications

- Pneumatic or Hydraulic Energy Based Machines
- Also applicable for powder metal presses, multi-slide/four slide machines, forging press controls and specialty or custom machine controls.

Consult the factory by phone at (412) 262-1115 or by email at sales@pressroomelectronics.com to review your project needs.

Model FPC Control System Ordering/Proposal Guide

Machine Control

Name _____
 Company _____
 Address _____
 City, State, Zip _____
 Phone _____
 Fax _____
 Email _____

Machine Information

Manufacturer _____

Model # _____ Serial # _____

Shop # _____ Tonnage _____

Maximum Stroke of Machine: _____

Does Machine have a shut height adjustment?
 N Y

What is the Machines Open Height? _____

Machine Type: Gap Straight Side
 4 Post H-Frame

Maximum Number of Machine Operators:
 1 2 3 4

Actuation: Hand Foot

How does machine operate?

- Does the ram return when the actuating means (hand or foot) is released? N Y
- Does the ram stop at midstroke when the actuating means is released? N Y
- Does the ram automatically return when actuating means is held operated? N Y
- Does the ram change speed during stroke? N Y
- Does ram dwell at the bottom of stroke before returning? N Y

Specify Sequence of Operation for the Machine.

Specify Maximum Machine Stroke Length: _____

Machine Input Power _____
 Voltage _____ Cycle _____ Phase _____

Location of Operator Controls on the NEMA 12 (IP 64) Control Panel

Left End Panel Door Right End
OR

FPC Module only to be installed into an existing control panel. Requires 18" x 18" x 6" space to mount the pre-wired backplate.

Fused Main Power Disconnect

Mounted on control panel _____ AMP
 Choose Style: IEC NEMA

Main Motor Magnetic Motor Starter

Choose Style: IEC NEMA
 Choose: Rev Non-Rev
 _____ HP _____ Full Load Amps
 Includes on/off push buttons and keyed selector switch forward/reverse when applicable.

Ram Adjust Magnetic Motor Starter

Choose Style: IEC NEMA
 _____ HP _____ Full Load Amps
 Includes up/down push buttons and keyed selector switch forward/reverse when applicable.

Machine Cycle Timing Devices

- Rotary exposed with 1:1 ratio for resolver
- Linear Transducer (install new)
- Re-use existing linear cams or limit switches

Machine Safety Valves

Safety Valves for Pneumatic Machines

- Machine has a dual safety valve
- Machine needs a dual safety valve

Specify current inlet port size (in) _____

Safety Valves for Hydraulic Machines

- Blocking valve (monitored dual valve required)

Specify voltage of existing Valve

24 VDC 230 VAC
 110 VAC 460 VAC

State inlet flow of Valve _____ GPM

State return flow of Valve _____ GPM

Email schematics and photos of the hydraulic system to sales@pressroomelectronics.com or fax them to (412) 262-1197.

Time Based Stopping Performance Monitor

Model LT-1900 (Linear Based) - Needed for Hydraulic Based Machines

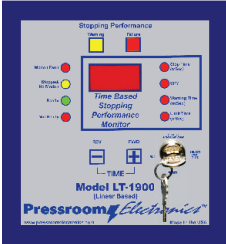

The LT-1900 is a time-based stopping performance monitor that utilizes a high resolution linear transducer and controller to measure the machine stopping time in milliseconds and also the SPM of the press. The linear transducer is attached to the subject machine and is driven on a 1:1 linear ratio by the machine. The machine stopping time of the machine will be displayed on every stop and can be easily read on the bright red light emitting diode (LED) display on the front panel of the unit. The SPM of the machine will be displayed during the machine cycle.

LT-1900 Stopping Performance Monitor System includes:

- LT-1900 controller (LT)
- Linear transducer with mounting brackets and magnet
- 40' (12m) linear transducer cable
- Dimensions and technical data
- Installation and operation manual



LT-1900 in NEMA 12 (IP 64) steel enclosure.

ORDERING PROCEDURE FOR LT-1900

1. Specify Mounting Style
 - E** Front Panel Mounting to be installed in an existing control panel.
 - C** Stand alone NEMA12 (IP 64) steel enclosure.
2. Specify Controller input power
 - 1** 24VDC
 - 2** 120VAC 50-60Hz
3. Specify Hydraulic Valve Coil Voltage
 - 1** 24VDC
 - 2** 120VAC 50-60Hz
4. Specify linear transducer length (must equal or exceed maximum machine stroke length)
 - 04** 4" (101mm) active length
 - 08** 8" (203mm) active length
 - 12** 12" (305mm) active length
 - 16** 16" (406mm) active length
 - 24** 24" (609mm) active length
 - *Over 24" (609mm) stroke required. Consult factory.

EXAMPLE PART NUMBER



3200SS Clutch/Brake Control with PressCam 8 Built-In



Pressroom  *Electronics*™

3200SS Clutch/Brake Control with PressCam 8

The Ultimate

The Ultimate is the most feature intensive air clutch punch press control available. The control conforms to all current OSHA and ANSI standards for control reliability and component monitoring. The system incorporates the Pressroom Electronics' PressCam 8 for complete punch press synchronization and flexibility for all peripheral punch press signaling needs such as feeds, die protection, lubrication, blowoffs, etc. All of the electrical timing adjustments for the complete press operation are done at the floor level by the operator. The PressCam 8 system also has a large job memory of 100. This gives the control the ability to remember 100 complete different jobs or die set-ups at the press. The memory concept at the press is an excellent feature due to the tremendous time saved during setups of various operations. Additional time is saved by being able to adjust or "fine tune" the stamping process while the press is running, which is an aid in maximizing press utilization. Detailed isolated product information on both the PressCam 8 and the 3200SS control system can be seen on the preceding pages of this catalog.



Part Number

30-012

Description

24vdc @ 2.2A power supply (90-260vac In) 3.9" L x 3.8" W x 1.4" H (99.1mm x 96.5mm x 35.6mm) for powering die sensors and auxiliary devices.

Standard Features

- Control Panel 3200SS conforms to all current OSHA and ANSI standards.
- Eleven cam programmable limit switch.
- Dual redundant outputs for all faults such as brake monitor, motion detector, etc.
- Built-in motion detector with fast response and dual speed limits.
- Brake Monitor - Time-based brake monitor with a digital display of both the brake stopping time and the brake fault limit setpoints in milliseconds. System also displays a brake fault when stopping times are exceeded.
- Built-in tachometer (SPM) and crank shaft angle in degrees with simultaneous digital display.
- Four built-in counters: stroke, batch, quality, and part.
- Built-in timers, adjustable from 1 ms to 10 seconds.
- Sixteen station die protection system (self-contained cyclic functions and two static functions) built-in with separate timing windows for each station based on the absolute position of the crankshaft. All the die protection timing windows are retained in the memory until the next time a particular die is set-up and run. Die protection timing windows can also be adjusted while the press is in motion.
- All the functions of the system that are timed or signaled through the PressCam 8 system can be retained in memory for 100 different die set-ups.
- All the operator timing adjustments are done at the floor level which eliminates the need for electricians to adjust rotary cam switches and microswitches.
- System self-diagnostics.
- Program security from tampering:
 1. Keyed selector switch for supervisory control
 2. Authorized code for program entry
- Accuracy $\pm 1^\circ$ for all timing circuits and can be "fine tuned" while the press is cycling.
- Eases the timing of all types of feeding equipment, AC and DC servo feeds, and air feeds.
- Very easy to program and use.
- System designed specifically for the metal stamping/metal forming industry.
- Main power disconnect and magnetic motor starters can be housed in the same control panel.
- Built-in 90° and 270° stop time tester.
- Tonnage monitoring optional.
- Ordering Procedure - Follow guidelines on Pages B8 - B9.

(For Custom Programming & Remote Field Upgrades, please consult factory at service@pressroomelectronics.com or (630) 443-9320.)

Components for the Metal Stamping / Metal Fabrication Industry

Components

Part Number	Model Number	Description
52-309	300	Calibrated Switch Actuator
39-021	301	Limit Switch with Actuator
39-120	302	Electric Foot Pedal
21-078	304	Air Cylinder Assembly
21-087	305	Automatic Ram Control Cylinder 3" x 2 1/2"
39-119	305A	Automatic Ram Control Cylinder (Extra Heavy Duty) 4" x 2 1/2"
39-020	306	Heavy Duty Pressure Switch
21-082	310A	4 Cam, Rotary Cam Limit Switch (with drive check)
21-089	310E	6 Cam, Rotary Cam Limit Switch (with drive check)
21-090	310G	8 Cam, Rotary Cam Limit Switch (with drive check)
21-091	310A-MD	4 Cam, Rotary Cam Limit Switch (with drive check & encoder)
21-092	310E-MD	6 Cam, Rotary Cam Limit Switch (with drive check & encoder)
21-093	310G-MD	8 Cam, Rotary Cam Limit Switch (with drive check & encoder)
39-114	311	3/4" Filter, Regulator, Lubricator
39-143	311A	1/2" Filter, Regulator, Lubricator
11-185	312	Run Bar Housing
UL-102-2P		Ergonomic Palm Button
UL-501	314	Operator Station
52-308	315	Sprockets & Chain for Rotary Limit Switch
52-307	318	Palm Button (including ring guard)
39-125	320D	Emergency Stop Button (30.5mm) 2 N.C. Latching
39-117	320DL	Emergency Stop Button (2.25") 2 N.C. Latching and Lockable
39-115	321	Top Stop Button (Yellow)
39-118	331	Universal Ring Guard only
52-227		Resolver unit (no cable)
45-020		Resolver cable (30') with connectors
39-013		NEMA only off/inch/single/continuous 4 position key switch
26-037		Silver Legend Plate (30.5mm) for AB key switch or button (must specify function)
26-041		Silver Legend Plate (22.5mm) for AB key switch or button (must specify function)
11-069		Adjustable Pedestal Stand - Model 8500 for #314 Operator Station (Range 32.5" to 47")
11-067		Adjustable Pedestal - Model 8000 for Light Curtain or Mirrors - 72" High
11-068		Adjustable Pedestal - Model 8096 for Light Curtain or Mirrors - 96" High
21-079		Model 9000 Swing Mount Brackets

Part Number

Description

30-012 24vdc @ 2.2A power supply (90-260vac In) 3.9" L x 3.8" W x 1.4" H (99.1mm x 96.5mm x 35.6mm) for powering die protection sensor or auxiliary devices.

Dual Valves, Main Power Disconnects and Magnetic Motor Starters are available on upcoming pages.

For additional accessories and/or replacement parts not listed, please contact the factory directly.

Punch Press Control System Components

Operation Station UL-501

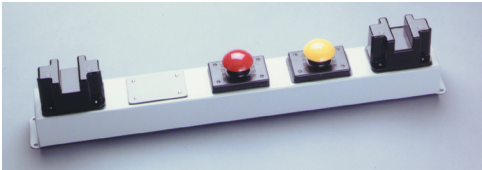

Operation Station No. UL-501

Includes two run palm buttons and one emergency stop palm button, internally wired.

Optional: Yellow top stop button added to operator run bar UL-501 (shown at the left).

Model Number 301 Part Number 39-021



Limit Switch with actuating arm

Oil-tight limit switch contains one set normally-open contacts and one set normally-closed contacts.

Model Number 302 Part Number 39-120



Electric Foot Pedal

An oil-tight foot switch. Contains one set, normally-open contacts, and one set normally-closed contacts. Includes a treadle guard to protect against accidental tripping. "Requires a point of operation guard when used for machine actuation," such as safety light curtains or safety interlock systems.

Dual Safety Valves See "Dual Safety Valves"



Dual Solenoid Valve

A most important aspect of double valve design is the incorporation of two separate 3/2 normally closed valve elements which are interconnected within a common valve body assembly. Each of the two valve elements is operated by its own 3/2 normally closed solenoid pilot valve. When simultaneously energized, both main valve elements are operated simultaneously. The probability of both independent valve elements malfunctioning on the same cycle is extremely remote.

Model Number 304 Part Number 21-078



Air Cylinder Assembly

A 1 1/2" (38mm) bore, 1" (25mm) stroke air cylinder, complete mounting bracket, and clevis.

Punch Press Control System Components

Pedestal Mounts Model 8000 & 8500



Pedestal Mounts

Painted OSHA yellow and made of heavy angle construction.

Model 8000: used to mount cornering mirrors or safety light curtains off of a machine. Order Part Number 11-067.

Model 8500: used to mount an operator station or palm buttons off of a machine and includes a top plate for mounting.

Both models are supplied with a floor mounting plate that can be lagged to the floor. Order Part Number 11-069.

Model Number 306 Part Number 39-020



Heavy Duty Pressure Switch

NEMA 12 oil-tight and dust-tight switch is adjustable from 1 to 115 PSI.

Model Number 310A Part Number 21-082



Rotary Cam Switch with Drive Check

The primary components which make up the Rotating Cam Limit Switch are Snap Action Switches and the Micro-Adjust Cams. The Micro-Adjust Cam Block consists of two cams with 180 degree lobes which can be adjusted relative to the cam shaft by simply rotating the adjusting disc. No tools are required to make this adjustment. The adjusting disc can be manually rotated. The cam block has a self-locking polyurethane gear which automatically locks the cams relative to the cam shaft, when the required contact setting has been obtained. Shown with drive check base.

Available with multiple cams and encoders.

Model Number 311 Part Number 39-114



Miniature Regulator, Oiler, Filter

Model Number 318 Part Number 52-307



Palm Button with Ring Guard

Includes ring guard and mounting enclosure.

Shut-Off Valve

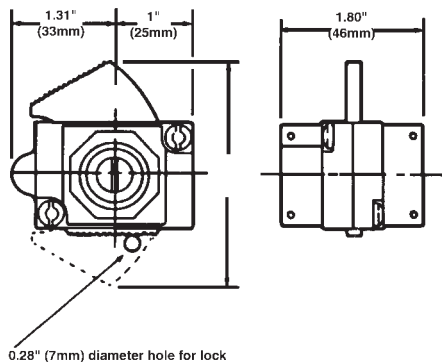

Ordering Procedure

Part Size PTF

- 1/4" (6mm)
- 3/8" (10mm)
- 1/2" (13mm)

Materials of Construction

Body: Zinc Slide: Acetal Plastic
Elastomers: Nitride

Three-Way Valves Exhaust Downstream Air in Closed Position

- Part #TO8-200-E1PA
- Part #TO8-300-E1PA
- Part #TO8-400-E1PA

Dual Safety Air Valves for Punch Presses

DUAL AIR VALVES

Old Style Dual Air Valves for Replacement

Part Number	Model Number	Description
52-980	Size 4	1/2" NPT Serpar Dual Air Valve (Manual Reset)
52-981	Size 4	3/4" NPT Serpar Dual Air Valve (Manual Reset)
52-982	Size 8	3/4" NPT Serpar Dual Air Valve (Air Reset)
52-983	Size 12	3/4" NPT Serpar Dual Air Valve (Air Reset)
52-984	Size 12	1" NPT Serpar Dual Air Valve (Air Reset)



New Style Dual Air Valves for Control Reliable Systems

Part Number	Model Number	Description
52-985	303A - Size 4	1/2" NPT inlet - 3/4" NPT outlet DM2 Dual Air Valve (Air Reset)
52-986	303B - Size 8	3/4" NPT DM2 Dual Air Valve (Air Reset)
52-987	303C - Size 12	1" NPT DM2 Dual Air Valve (Air Reset)



Dual Valve Sizing for Air Clutch Punch Presses

Guideline of Minimum Valve Size to use.

Valve Size	Press Tonnage
Size 4	0 to 90 Ton
Size 8	100 to 200 Ton
Size 12	200 to 500 Ton

For Machines larger than 500 Ton, please consult factory.

AIR LOCKOUT VALVES

Part Number	Description
39-145	Air Lock-Out Valve - 1/4" (6mm)
39-146	Air Lock-Out Valve - 3/8" (10mm)
39-147	Air Lock-Out Valve - 1/2" (13mm)
39-136	Air Lock-Out Valve - 3/4" (19mm)
39-148	Air Lock-Out Valve - 1" (25.4mm)

IEC Style**Main Power Disconnects and Magnetic Motor Starters****MAIN POWER DISCONNECTS - IEC STYLE****All rated at 600 VAC**

Part Number	Model Number	Description	240 VAC HP	480 VAC HP
52-911	ID30	0-30 Amp IEC	7.5	15
52-912	ID60	31-60 Amp IEC	15	30
52-913	ID100	61-100 Amp IEC	30	60
52-914	ID200	101-200 Amp IEC	60	125
52-915	ID400	201-400 Amp IEC	125	200

MAGNETIC MOTOR STARTERS - IEC STYLE**Conforms to the IEC Standard 947**

Part Number	Description	240 VAC HP	480 VAC HP
52-961-INR-A	Non-Reversing	2	5
52-962-INR-B	Non-Reversing	3	7.5
52-963-INR-C	Non-Reversing	5	10
52-964-INR-D	Non-Reversing	7.5	15
52-965-INR-E	Non-Reversing	10	20
52-966-INR-F			25
52-967-INR-G	Non-Reversing	15	30
52-968-INR-H	Non-Reversing	20	40
52-969-INR-I	Non-Reversing	25	50
52-970-INR-J	Non-Reversing	30	60
52-971-INR-K	Non-Reversing	40	75
52-972-INR-L	Non-Reversing	60	150
52-941-IRR-A	Reversing	2	5
52-942-IRR-B	Reversing	3	7.5
52-943-IRR-C	Reversing	5	10
52-944-IRR-D	Reversing	7.5	15
52-945-IRR-E	Reversing	10	20
52-946-IRR-F			25
52-947-IRR-G	Reversing	15	30
52-948-IRR-H	Reversing	20	40
52-949-IRR-I	Reversing	25	50
52-950-IRR-J	Reversing	30	60
52-951-IRR-K	Reversing	40	75
52-952-IRR-L	Reversing	60	150

Note -- The Main Power Disconnect and Magnetic Motor Starters are priced to automatically include all applicable legend plates, push buttons, key switches (if required), larger control panel and factory installation.

NEMA Style

Main Power Disconnects and Magnetic Motor Starters

MAIN POWER DISCONNECTS - NEMA STYLE

All rated at 600 VAC

Part Number	Description	240 VAC HP
52-906-NED-30	0-30 Amp Rating	7.5
52-907-NED-60	31-60 Amp Rating	15
52-908-NED-100	61-100 Amp Rating	30
52-909-NED-200	101-200 Amp Rating	60
52-910-NED-400	201-400 Amp Rating	125

Part Number	Description	480 VAC HP
52-901-NED-30	0-30 Amp Rating	15
52-902-NED-60	31-60 Amp Rating	30
52-903-NED-100	61-100 Amp Rating	60
52-904-NED-200	101-200 Amp Rating	125
52-905-NED-400	201-400 Amp Rating	200

MAGNETIC MOTOR STARTERS - NEMA STYLE

Part Number	Description	240 VAC HP	480 VAC HP
52-931-NENR-00	Non-Reversing	1.5	2
52-932-NENR-0	Non-Reversing	3	5
52-933-NENR-1	Non-Reversing	7.5	10
52-934-NENR-2	Non-Reversing	15	25
52-935-NENR-3	Non-Reversing	30	50
52-936-NENR-4	Non-Reversing	50	100
52-921-NERR-00	Reversing	1.5	2
52-922-NERR-0	Reversing	3	5
52-923-NERR-1	Reversing	7.5	10
52-924-NERR-2	Reversing	15	25
52-925-NERR-3	Reversing	30	50
52-926-NERR-4	Reversing	50	100

Note -- The Main Power Disconnect and Magnetic Motor Starters are priced to automatically include all applicable legend plates, push buttons, key switches (if required), larger control panel and factory installation.

Die Protection Sensor Interface

Remote Die Box

Part Number	Description
53-450	Six (6) channel Remote Die Box Includes: Individual Channel Indicators Cable - 45' quick disconnect (12 conductor) minimizes wiring installation time Power Supply included to power sensors - 24VDC at 2.5 AMP

The six (6) channel remote die box allows you to quickly change out the die sensors by using either plug connectors or Banana jacks. Provides +24VDC power to active sensors and monitors the status (PNP or NPN).



45' of 16 Pin Circular Connection Cable:

Pin	Wire Color	Description
1	BRN	120VAC L input
2	N/C	
3	RED	Earth Ground
4	ORG	+24v out (from power supply)
5	YEL	+24v out (from power supply)
6	GRN	Die #6 output
7	Shield	Case Ground
8	N/C	
9	BLU	Die #5 output
10	VLT	Ground
11	GRY	Die #2 output
12	WHT	Die #1 output
13	BLK	Die #3 output
14	BK/WT	Die #4 output
15	RD/WT	120VAC N input
16	N/C	

Indicator LED's

- RED = PNP
- GREEN = NPN

Banana Jack: Passive GND sensors when used you must jumper Pin 1 to 3 on Lumberg receptacle (female) (i.e. NPN only)

Active PNP or NPN Sensors

Pin	Description
1	Jumper to Pin 3 if NPN, to Pin 4 if PNP
2	Sensor Output (NPN or PNP)
3	+24VDC from Die Box power supply
4	Ground from Die Box power supply

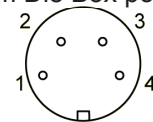

Shown view from solder end of Plug

Enclosure: NEMA 12, 13, IP54 painted steel (blue)

Enclosure Dimensions: 8" (203mm) Height
6" (152mm) Wide
3.5" (89mm) Deep

Machine Safeguarding Products

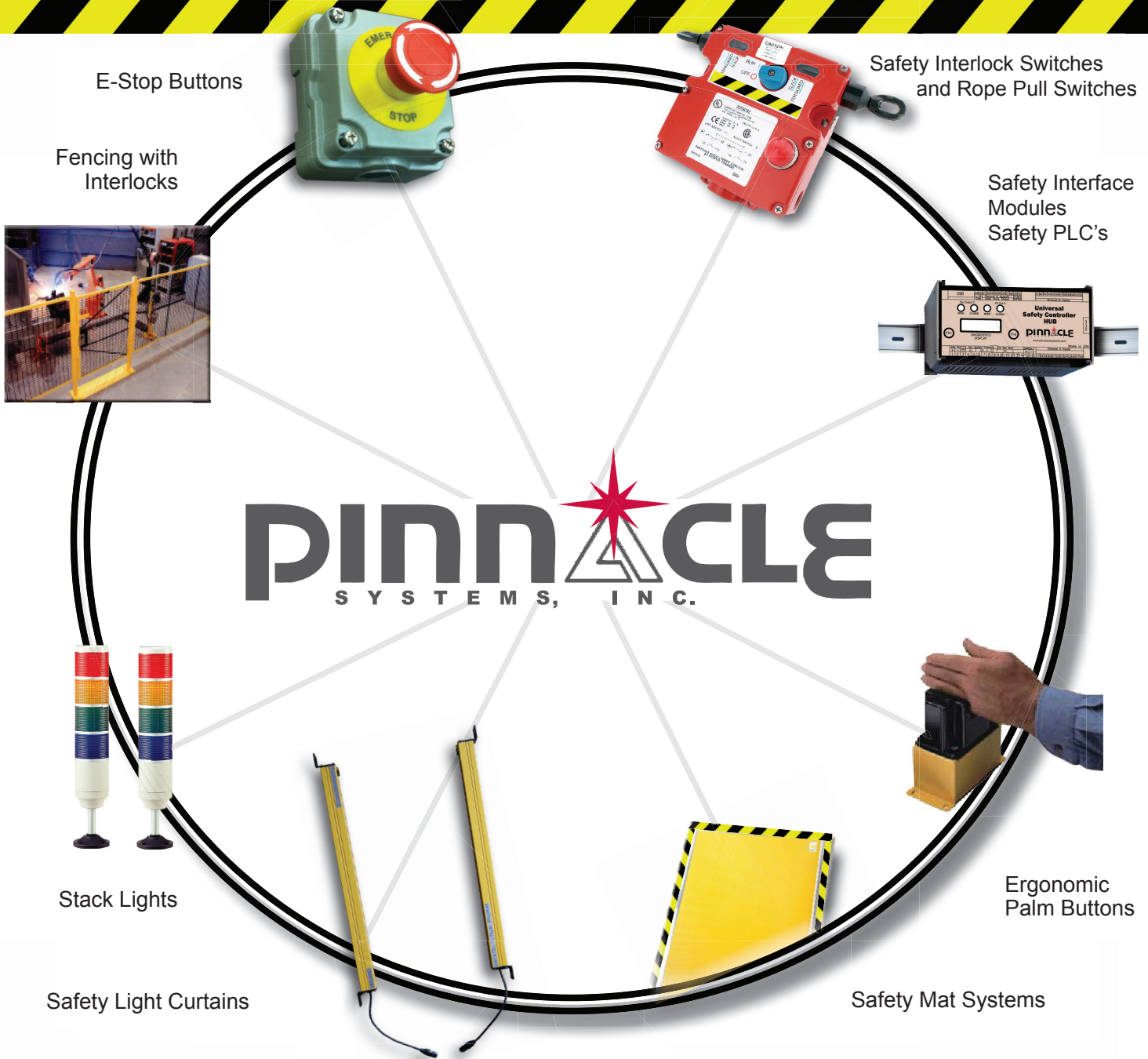

- Safety Light Curtains (all types and styles)
- Safety Mat Systems (all types and styles)
- Universal Safety Controller HUB / Safety PLC
- Ergonomic Palm Buttons *UltraTouch*®
- Safety Interlock Switches (explosion proof)
- Fencing with Interlocks
- Stack Lights and E-Stops
- OSHA and ANSI Compliant Controls
- Customized “control reliable” controls for dual solenoid activated pneumatic & hydraulic safety valve applications
- Energy Isolation and Single Point Lockout Systems
- Plant Surveys and Risk Assessment
- Stainless Steel Enclosures Available
- Customized Control Panels

Pressroom Electronics™

WARRANTY

Manufacturer warrants that this product will be free from defects in material and workmanship for a period of one year from the date of shipment thereof. Within the warranty period, manufacturer will repair or replace such products which are returned to it with shipping charges prepaid and which will be disclosed as defective upon examination by the manufacturer. This warranty will not apply to any product which will have been subject to misuse, negligence, accident, restriction, and use not in accordance with manufacturer's instructions or which will have been altered or repaired by persons other than the authorized agent or employees of the manufacturer.

DISCLAIMER

The provisions of the paragraph "Warranty" are the sole obligations of the manufacturer and exclude all other warranties of merchantability, expressed or implied. Further, there are no warranties which extend beyond the above warranty.

DISCLAIMER

Pressroom Electronics does not assume liability for the contents of this publication or the use of any products described. Pressroom Electronics reserves the right to make changes to the products or any catalogs without further notice.

ERRORS AND OMISSIONS

Information presented by Pressroom Electronics has been checked and is believed to be accurate; however, no responsibility is assumed for clerical, typographical or proofreading errors or omissions.

LIMITATION OF LIABILITY

In the event of any claim or breach of any obligations of manufacturer under any order, whether expressed or implied, and particularly in the event of any claim or a breach of the warranty or warranties contained in the paragraph "Warranty" or of any other warranties, expressed or implied which might, despite the paragraph entitled "Disclaimer," be determined to be incorporated in any order, the company shall under no circumstances be liable for any consequential or special damages, either in law or in equity, or for losses or expenses or claims for the same arising from the use of, or inability to use, the products of the manufacturer for any purpose whatsoever.

WARNING

The entire machine safety system must be tested at the start of every shift. Machine testing should include: (1) proper machine operation and stopping capability; and (2) verification of proper installation and settings of all point of operation guards and devices before the operation is released for production.

CHANGE IN SPECIFICATIONS

Product specifications and accessories may be changed at any time based on improvements and other reasons. It is our practice to change part numbers when published ratings or features are changed, or when significant construction changes are made. However, some specifications of the Product may be changed without any notice. When in doubt, special part numbers may be reassigned to fix or establish key specifications for your application. Please consult the factory.

Additional products to achieve your **Total Safety Solution!!!**

- Safety Light Curtains (All Types and Styles)
- Universal Safety Controller HUB / Safety PLC
- Safety Mat Systems and Controls
 - Area Guarding Systems
 - NSD Safety Mat Systems
 - STTS Safety Mat Systems
 - Direction of Travel Mats
 - High-Temp Welding Mats
- Ergonomic Palm Buttons
 - UltraTouch Palm Buttons
- Safety Interlock Switches (including explosion proof)
- Customized "control reliable" controls for dual solenoid activated pneumatic and hydraulic valve applications
- Fencing with Interlocks
- E-Stop Buttons
- Stack Lights

- Energy Isolation and Single Point Lockout Systems
- Plant Surveys, Risk Assessment & Installation Services
- Customized Control Panels; Stainless Steel enclosures available for all products

Punch Press / Metal Stamping Industry

- Resolver or Rotary Cam Based Clutch / Brake Controls - OSHA/ANSI Compliant
- Punch Press Automation Controllers
- Time-Based Brake Monitors
- Programmable Limit Switches
- Die Protection & Tonnage Monitoring Systems
- Servo Feed Interfaces

Press Brake Guarding and Controls

- Press Brake Guarding for Mechanical, Air Clutch and Hydraulic Press Brakes
- Press Brake Control Systems



Pressroom *Electronics*™

www.pressroomelectronics.com

Sales and Marketing Office

P.O. Box 99875
Pittsburgh, PA 15233

Phone: (412) 262-1115

Fax: (412) 262-1197

sales@pressroomelectronics.com

orderentry@pressroomelectronics.com

Manufacturing and Service Center

3715 Swenson Avenue
Saint Charles, IL 60174

Phone: (630) 443-9320

Fax: (630) 443-9346

service@pressroomelectronics.com

We have designed our equipment to the very highest performance and safety standards known to the current technological state of the art, as evidenced by our U.S.A. and foreign patents issued and pending. However, the installation, usage, and suitability, and fitness of our equipment for any purpose, known or unknown, is interdependent upon the performance of other equipment not manufactured, installed, secured or maintained by Pressroom Electronics.

We cannot and do not accept responsibility for any overall system performance when factors such as these, are beyond our control.

Part#: PEDM-A-BOAF